

®

Cavaletti

CADEIRAS PROFISSIONAIS



Cavaletti PRO



## Cavaletti Pro

Espaços de trabalho dinâmicos pedem assentos confortáveis, práticos e duráveis, que se integrem à arquitetura de cada ambiente. Criada para atender áreas operativas e gerenciais, a linha Pro oferece soluções para atender de forma inteligente uma grande variedade de usuários, com alto índice de conforto e funcionalidade.

## CARACTERÍSTICAS



**APOIO DE CABEÇA**  
Apoio de Cabeça com 4 posições de regulagem e 40 mm de curso. Com dimensões generosas, oferece maior suporte a região cervical.



**MECANISMOS**  
Mecanismo Sincron ou Sistema Reclinador de Encosto (SRE), ambos com regulagem de altura do encosto, ou Relax.

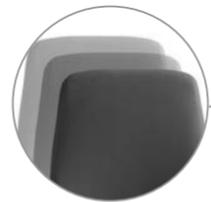

**ESPALDAR**  
Espaldar com três opções de altura e com curvaturas anatômicas para maior suporte da coluna vertebral.



**BASES**  
Bases em Alumínio, Nylon ou Aço com Capa. Rodízios em Nylon ou PU.



**38001 L AC**  
**Presidente Giratória**  
Sincron  
Braço SL  
Base Alumínio



**REVESTIMENTOS**  
Tecidos selecionados com costuras duplas nas opções: Poliéster, Space, Mescla, Politéx, Vinil, Haven, CEC ou Couro Natural.



**BRAÇOS**  
Modelos giratórios com Braços Reguláveis SL, SL New PU ou 2D (todos com opção de Regulagem Lateral) ou 3D. Modelos fixos com Braços Integrados.



**ASSENTO**  
Assento em espuma injetada com regulagem de altura à gás. Opção de regulagem de profundidade.



**ESTRUTURA**  
Bases fixas na opção Balanço com ou sem Braços Integrados (S ou SI) e Sapata Estabilizadora. Acabamento Cromado ou Preto Microtexturizado.

## CONFIGURAÇÕES



**38001 L**  
**Presidente Giratória**  
Sincron  
Braço SL New PU  
Base Aço com Capa



**38001 SRE**  
**Operacional Alta**  
Sistema Reclinador do Encosto  
Braço SL  
Base Aço com Capa



**38003 SRE**  
**Operacional Média**  
Sistema Reclinador do Encosto  
Braço SL  
Base Aço com Capa



**38022 SRE**  
**Stool**  
Sistema Reclinador do Encosto  
Braço SL  
Base Aço com Capa



**38006 SI**  
**Aproximação Alta**  
Estrutura SI  
Braços Integrados



**38006 S**  
**Aproximação Alta**  
Estrutura S



**38007 SI**  
**Aproximação Média**  
Estrutura SI  
Braços Integrados



**38007 S**  
**Aproximação Média**  
Estrutura S



**38010**  
**Longarina Média**

# DESENHOS TÉCNICOS

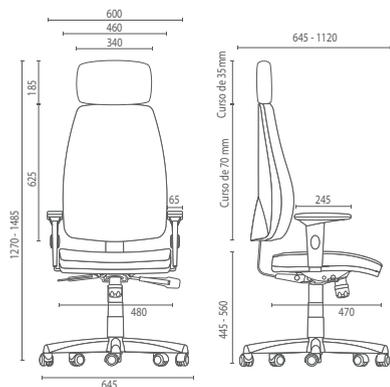

38001 AC Presidente Giratória

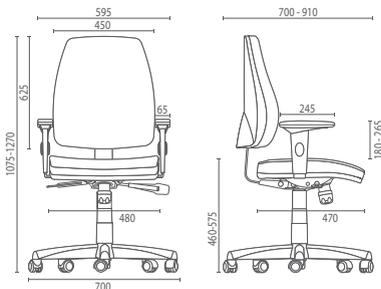

38001 L Presidente Giratória

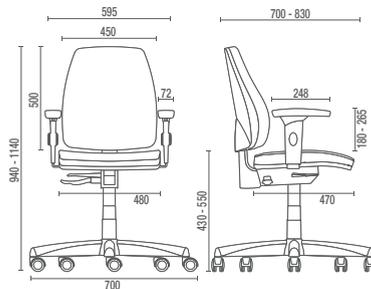

38001 SRE Operacional Alta

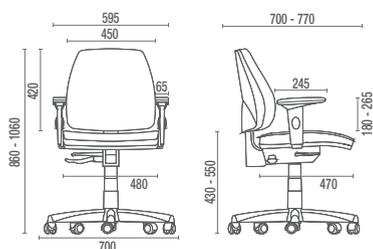

38003 SRE Operacional Média

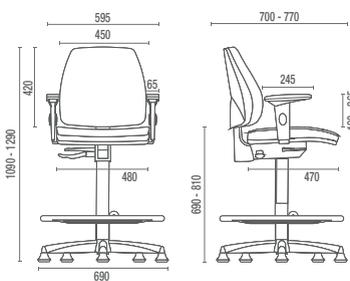

38022 SRE Caixa Média

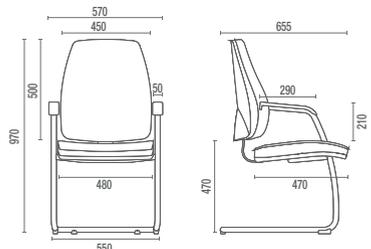

38006 SI Aproximação Alta com Braços Integrados

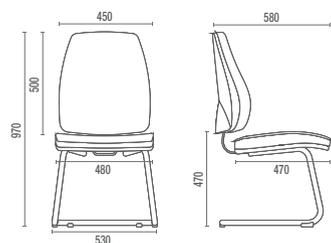

38006 S Aproximação Alta

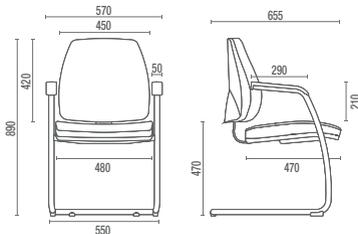

38007 SI Aproximação Média com Braços Integrados

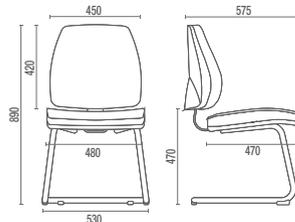

38007 S Aproximação Média

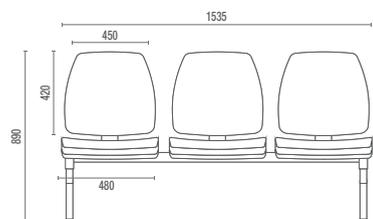

38010 Longarina Média

Larguras:  
2L - 1010mm  
4L - 2070mm  
5L - 2600mm

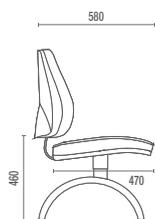

Cavaletti S/A Cadeiras Profissionais  
Rua Dr. Hiram Sampaio, 550  
Erechim/RS Brasil 99706-461  
Fone/Fax: (54) 3520.4100  
atendimento@cavaletti.com.br  
www.cavaletti.com.br

