

PORTFÓLIO DE PRODUTOS

Cavaletti

OPERATIVAS

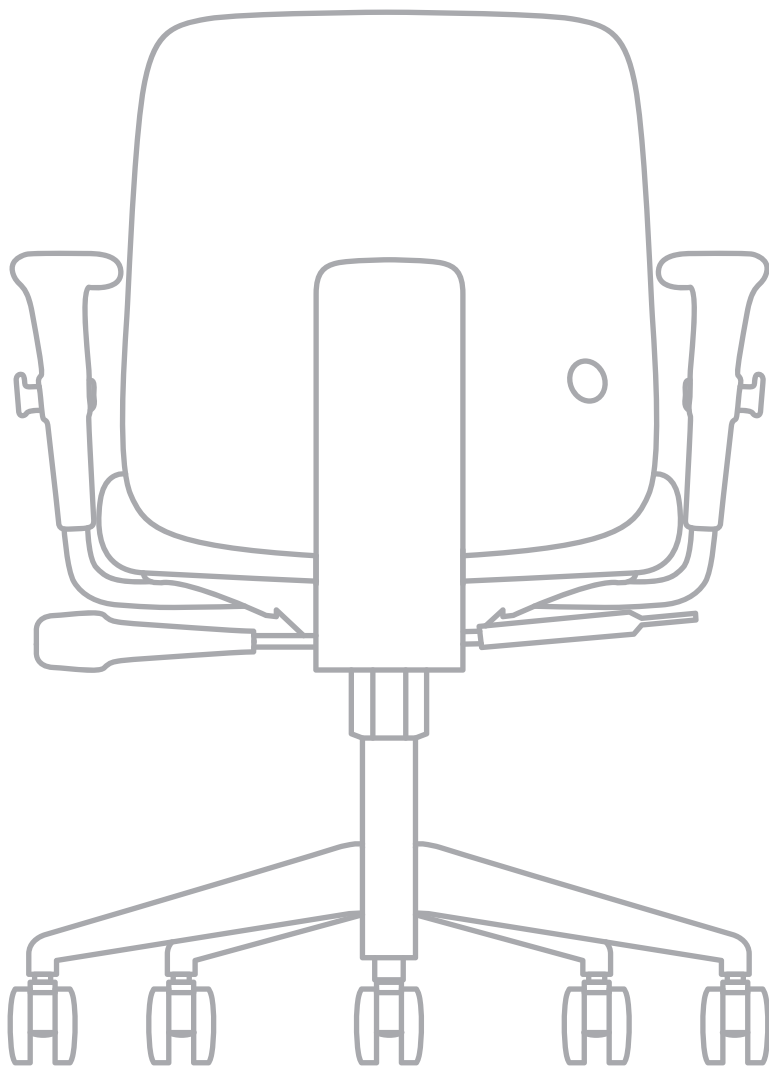

Cavaletti

CADEIRAS PROFISSIONAIS



↗
05
COFFEE

03
MEET

Cavaletti Flip

08 BREAK

02 STUDIO



Cavaletti Flip

Dinamismo e agilidade são qualidades comuns aos ambientes corporativos contemporâneos. A Cavaletti desenvolveu a linha Flip para atender às exigências de versatilidade e qualidade ergonômica nos mais variados tipos de uso.

CARACTERÍSTICAS



MECANISMOS
Sistema Reclinador do Encosto (SRE), com regulagem de altura do encosto para modelo Executiva Giratória.



ESPALDAR
Estrutura em plástico injetado de alta resistência. Disponível na cor Preto.

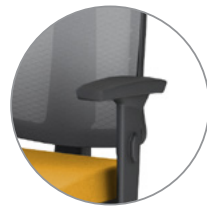

BRAÇOS
Opção de composição em todos os braços Cavaletti (exceto ID).



TELA
Membrana que se adapta à curvatura da coluna, proporcionando suporte e ventilação constantes. Disponível nas cores Preto e Cinza.



ASSENTO
Assento em espuma injetada, com regulagem de altura à gás.

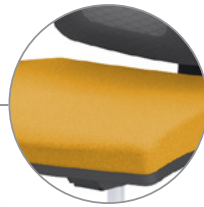

REVESTIMENTOS
Revestimentos disponíveis em Poliéster, Polítex, Mescla, Vinil, CEC, Space.



BASES
Opção de bases em Aço com capa Nylon e Alumínio. Rodízios 50mm ou 65 mm, em Nylon ou PU.



ESTRUTURAS
Estrutura S Fixa, com ou sem braços. Estrutura Z fixa com ou com rodízios e Braços Integrados. Acabamento Cromado ou Pintura em Preto Microtexturizado.

CONFIGURAÇÕES



43.103 SRE
Executiva Giratória
Sistema Reclinador de Encosto (SRE)
Braços TC
Base Nylon
Rodízios 65mm



43.106 S
Executiva Aproximação
Estrutura S
Braços Loop



43.106 SI
Executiva Aproximação
Estrutura SI
Braços Integrados



43.106 Z
Executiva Aproximação
Estrutura Z
Braços Integrados



43.106 Z ROD
Executiva Aproximação
Estrutura Z com rodízios 50mm
Braços Integrados



43.122
Stool
Encosto Fixo
Braços TC
Base Nylon com sapatas (Polaina Opcional)
*Sistema Reclinador de Encosto (SRE) Opcional



43.110
Executiva Longarina
Braços Loop Intercalado
Estrutura Pé Preto ou Cromado
*A travessa é disponível apenas em Preto
**Não disponível com os Braços TC

TELAS

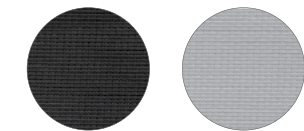

Preto

Cinza

DESENHOS TÉCNICOS

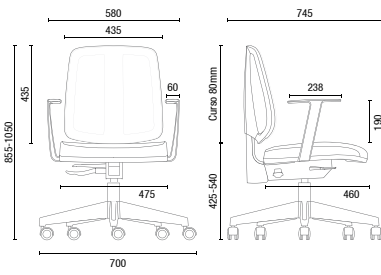

43.103 SRE Executiva Giratória

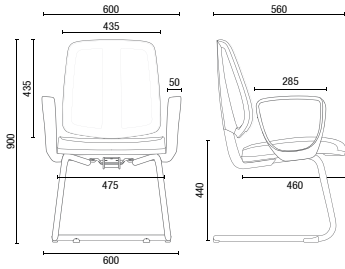

43.106 S Executiva Aproximação

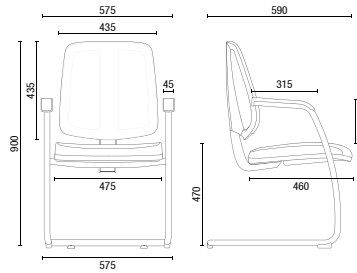

43.106 SI Executiva Aproximação

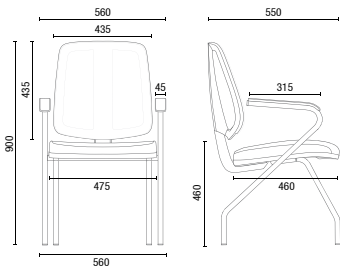

43.106 Z Executiva Aproximação

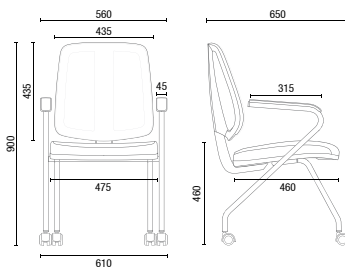

43.106 Z ROD Executiva Aproximação

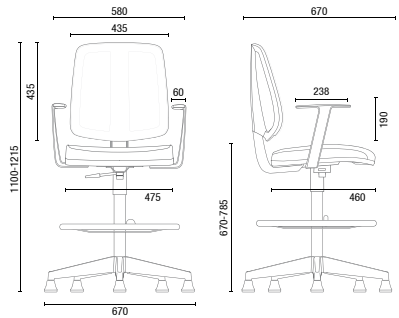

43.122 Stool

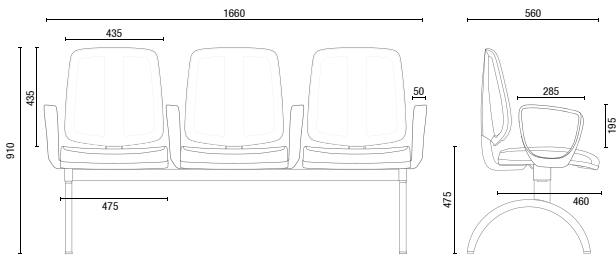

43.110 Executiva Longarina

OBS: Medidas extremas obtidas sem o uso de gabarito de carga.



Cavaletti - Fábrica e Showroom
Rua Dr. Hiram Sampaio, 550
Erechim/RS Brasil 99.706-461
Fone/Fax: (54) 3520.4100
atendimento@cavaletti.com.br
www.cavaletti.com.br



Cavaletti[®]

CADEIRAS PROFISSIONAIS



Cavaletti Vélo

Cavaletti Vélo

Dinamismo, agilidade e velocidade são indispensáveis no ambiente corporativo contemporâneo. Para ele, a Cavaletti criou a Linha Vélo, um produto inspirado nos conceitos de flexibilidade e leveza para oferecer ergonomia e conforto dinâmico para todos os tipos de uso. Um projeto global, com design original, Made in Brazil.



Parceiro da Cavaletti desde 2011, Marc Sapetti nasceu em Andorra e formou-se em design industrial em Barcelona. Nos anos seguintes trabalhou em escritórios relevantes na Europa, culminando recentemente com a criação do seu próprio escritório. Hoje, a Sapetti Design Consultancy é um estúdio multipremiado, entre eles IF Awards (Cavaletti Go) e Good Design Award (Cavaletti Idea). Para Marc, "Design não é só um produto, mas a soma de diferentes fatores como engenharia, comunicação, design e ergonomia".



CARACTERÍSTICAS



APOIO DE CABEÇA

Com dimensões generosas, oferece maior suporte a região cervical. Removível, pode ser encaixado sem o uso de ferramentas. Área de contato com revestimento em espuma PU Soft Touch.



ESPALDAR

Encosto alto em todas as versões. Apoio lombar ajustável (modelos operativos). Disponível nas cores Cinza Claro e Carbon. Opção de capa acolchoada em CEC ou Couro Natural.



MECANISMOS

Mecanismo Synchron de 4 estágios com regulação de tensão por manípulo central. Opção de Plataforma Giratória para salas de reunião (SR).



TELA

Membrana inteligente de alta resistência, que se adapta a curvatura da coluna proporcionando suporte e ventilação constantes. Disponível em oito cores exclusivas.



ASSENTO

Assento em espuma injetada, com regulação de Profundidade (modelos operativos). Regulação de Altura à Gás. Revestimentos disponíveis em Poliéster, Mescla, Politex, Couro Ecológico ou Natural.

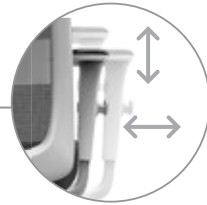

BRAÇOS

Braços ID reguláveis em altura e afastamento lateral, com opção de revestimento em couro. Braços 3D opcionais.



BASES

Opção de bases em Alumínio ou Nylon. Rodízios de 60mm em Nylon ou PU.



ESTRUTURAS

Estruturas com rodízio ou fixa Balanço, com ou sem Braços Integrados (SI) e Pintura nas cores Prata ou Preto Ultrafosco Microtexturizado.

CONFIGURAÇÕES



42.101 AC
Giratória Operativa
Synchron RP
Braços ID
Base Alumínio
Apoio Lombar
Apoio de Cabeça
Capa Acolchoada



42.101 AC
Giratória Operativa
Synchron RP
Braços ID
Base Nylon
Apoio Lombar
Apoio de Cabeça



42.101
Giratória Operativa
Synchron RP
Braços ID
Apoio Lombar
Base Nylon



42.101 SR
Giratória Reunião
Plataforma Giratória
Base Nylon



42.106 ROD
Aproximação Giratória
Estrutura P
Braços Integrados



42.106 SI
Aproximação
Estrutura SI
Braços Integrados

TELAS

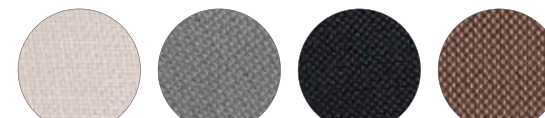

Branco Metal

Grafite

Preto

Marrom

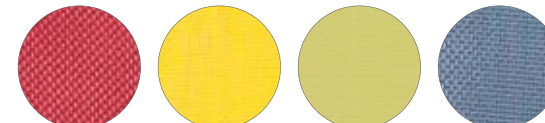

Vermelho

Amarelo

Verde Lima

Azul

SUPERFÍCIES PLÁSTICAS



Cinza Claro



Carbon

DESENHOS TÉCNICOS

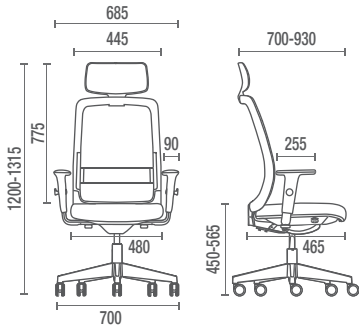

42.101 AC Giratória Operativa

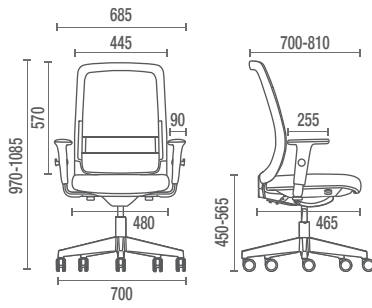

42.101 Giratória Operativa

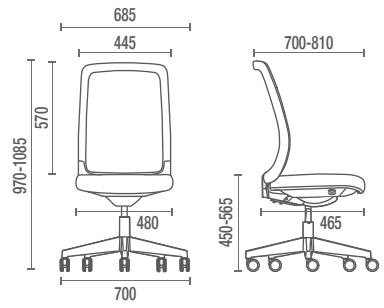

42.101 SR Giratória Reunião

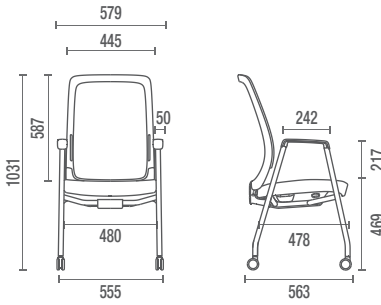

42.106 ROD Aproximação Giratória

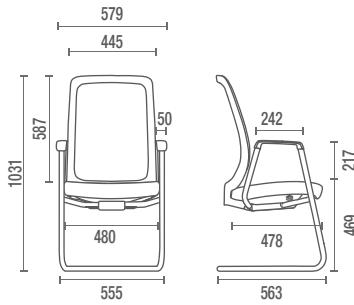

42.106 SI Aproximação



Cavaletti - Fábrica e Showroom
 Rua Dr. Hiram Sampaio, 550
 Erechim/RS Brasil 99.706-530
 Fone/Fax: (54) 3520.4100
 atendimento@cavaletti.com.br
 www.cavaletti.com.br



Cavaletti

CADEIRAS PROFISSIONAIS



Cavaletti Idea

Cavaletti Idea

Novas ideias para novos tempos. A Cavaletti Idea busca tornar acessível o design e a alta qualidade ergonômica para todos os tipos de escritório. Um produto feito no Brasil, com alto padrão de qualidade e inspirado nos conceitos contemporâneos de trabalho colaborativo.

CARACTERÍSTICAS

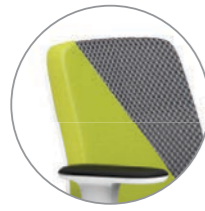

REVESTIMENTOS
Espaldar com estrutura interna flexível e duas opções de acabamento: Soft (nas opções Poliéster, Space ou Poliéster Mescla) ou Mesh (na opção Space).



MECANISMOS
Mecanismo Synchron de 4 estágios com regulagem de tensão por manípulo central. Opção de Plataforma Giratória para salas de reunião (SR).



CORES
Três opções de cores para as superfícies plásticas principais: Branco Off, Cinza Claro ou Carbon.



BRAÇOS
Braços 2D exclusivos do modelo, reguláveis em altura e afastamento lateral. Opção de Braços 3D.



ESPALDAR
Espaldar com regulagem de altura e acionamento por botão.



ASSENTO
Assento em espuma injetada, Regulagem de Profundidade e Regulagem de Altura à Gás. Revestimentos disponíveis em Poliéster, Space e Poliéster Mescla.



BASES
Opção de bases em Alumínio ou Nylon. Rodízios de 60mm em Nylon ou PU.



ESTRUTURAS
Estrutura fixa Balanço com Braços Integrados (SI) e Pintura em Prata ou Preto Ultrafosco Microtexturizado.

CONFIGURAÇÕES

IDEA SOFT



40.101
Giratória Alta
Synchron RP
Braços 2D
Base Alumínio



40.102
Giratória Média
Synchron RP
Braços 2D
Base Alumínio



40.106 SI
Aproximação
Estrutura SI
Braços Integrados

IDEA MESH



40.202
Giratória Média
Synchron RP
Braços 2D
Base Nylon



40.202 SR
Giratória Média
Plataforma Giratória
Base Nylon



40.206 SI
Aproximação
Estrutura SI
Braços Integrados

CORES

Três opções de tonalidade para superfícies plásticas principais.



Branco Off



Cinza Claro



Carbon

DESENHOS TÉCNICOS

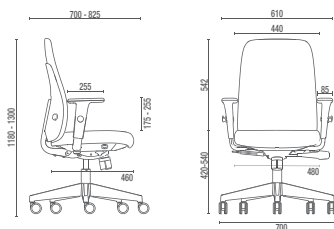

40.101 **Giratória Alta**

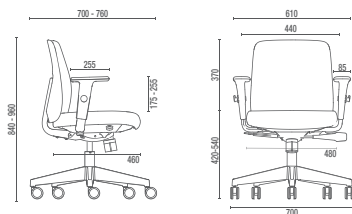

40.102 / 40.202 **Giratória Média**

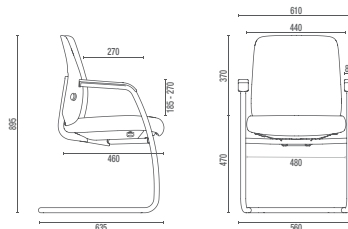

40.106 SI / 40.206 SI **Aproximação**

Cavaletti

CADEIRAS PROFISSIONAIS



Cavaletti Start



Cavaletti Start

A linha Start oferece uma diversidade de modelos que se adaptam a diferentes ambientes. Com alta qualidade e acabamentos selecionados, os modelos Start são ergonômicos e buscam o conforto ideal para o dia-a-dia dos escritórios.

CARACTERÍSTICAS

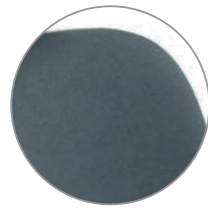

ACABAMENTOS

Diferentes opções de revestimento: Polipropileno, Poliéster, Vinil, Couro Ecológico e Space.



MECANISMOS

Mecanismo Synchron com regulagem de altura do encosto ou Relax com opção de regulagem de encosto para os modelos Presidente e Diretor. Sistema de Reclinação do Encosto (SRE) com regulagem de altura do encosto para os modelos Executiva e Secretária.



ESPALDAR

Espaldares em quatro alturas diferentes: Presidente, Diretor, Executiva e Secretária.



ASSENTO

Assento em espuma injetada com Regulagem de Altura à Gás.



BASES

Bases em Aço com Capa. Rodízios 50mm em Nylon ou PU.



BRAÇOS

Modelos giratórios com Braços Reguláveis SL, SL New PU ou 2D (todos com opção de Regulagem Lateral) ou 3D. Braços fixos nas opções Americano, Corsa ou Style.



ESTRUTURAS

Estrutura fixa nas opções Arco (A), Palito (P) ou Balanço (S).

CONFIGURAÇÕES



4001
Presidente Giratória
Relax
Braço SL



4002
Diretor Giratória
Relax
Braço SL



4003
Diretor Giratória Extra
Relax
Braço SL com Regulagem Lateral



4006 S
Diretor Aproximação
Estrutura S
Braço Americano



4006 PUE
Diretor Universitária
Prancheta Escamoteável
Braço Americano



4103
Executiva Giratória
Sistema de Reclinação do Encosto
Braço SL New PU



4107 S
Executiva Aproximação
Estrutura S



4123
Executiva Caixa
Sistema de Reclinação do Encosto
Braço SL New PU



4004
Secretária Giratória
L2048 com Regulagem
Braço SL



4008 A
Secretária Aproximação
L2048 Fixo
Estrutura Arco



4022
Secretária Caixa
L2048 com Regulagem



L2048
Regulagem de Altura do Encosto (4004 e 4022)



4005
Diretor Longarina
Braço americano



4110
Executiva Longarina



4005 U / 4110 U
Prancheta Escamoteável
Opcional para 4005 e 4110



4009
Secretária Longarina
L2048 fixo

DESENHOS TÉCNICOS

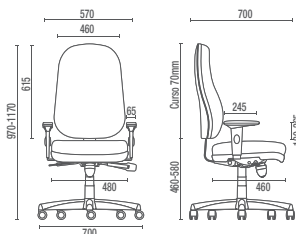

4001 Presidente Giratória

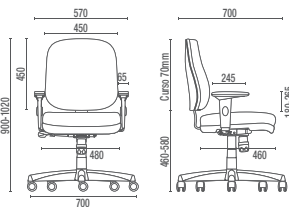

4002 Diretor Giratória

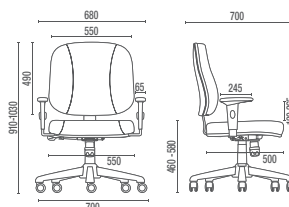

4003 Diretor Giratória Extra

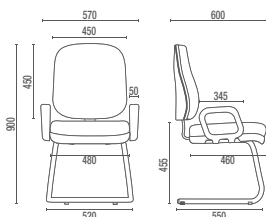

4006 S Diretor Aproximação

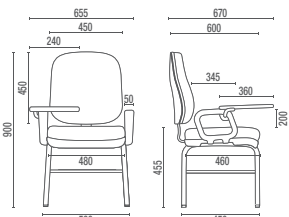

4006 PUE Diretor Universitária

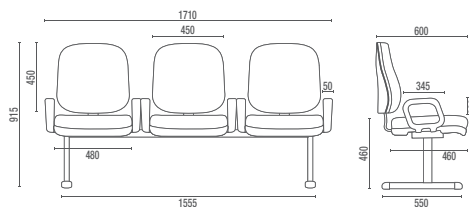

4005 Diretor Longarina
Larguras com Braço Duplo:
2L – 1140mm 3L – 1710mm 4L – 2280mm 5L – 2850mm

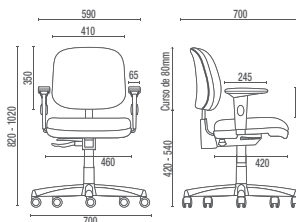

4103 SRE Executiva Giratória

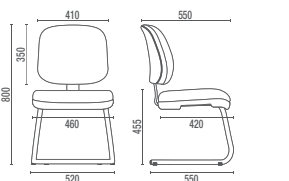

4107 S Executiva Aproximação

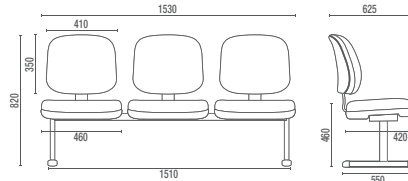

4110 Executiva Longarina

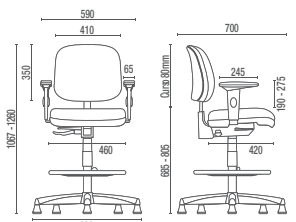

4123 SRE Executiva Caixa

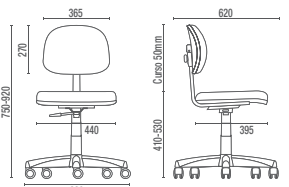

4004 Secretária Giratória

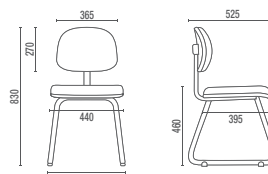

4008 A Secretária Aproximação

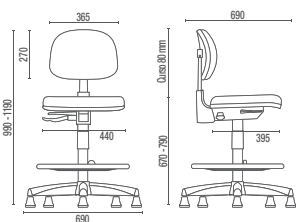

4022 SRE Secretária Caixa

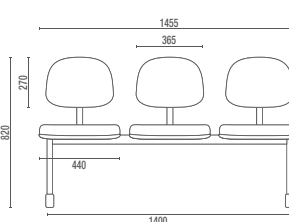

4009 Secretária Longarina



Cavaletti - Fábrica e Showroom
Rua Dr. Hiram Sampaio, 550
Erechim/RS Brasil 99.700-000
Fone/Fax: (54) 3520.4100
atendimento@cavaletti.com.br
www.cavaletti.com.br



Cavaletti®

CADEIRAS PROFISSIONAIS



Cavaletti StartPlus



Cavaletti StartPlus

Com opções diferenciadas de acabamentos, a linha Start Plus alia cuidado artesanal à tecnologia de ponta. São três padronagens de costuras disponíveis que completam ambientes sofisticados de forma sutil, porém marcante.

CARACTERÍSTICAS

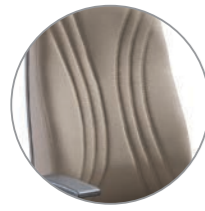

REVESTIMENTOS

Diferentes opções de revestimento: Polipropileno, Poliéster, Vinil, Couro Ecológico e Space. Três opções de costura conforme modelo (3000, 6000 e 7000).



ESPALDAR

Espaldar em quatro alturas diferentes conforme modelos: Presidente, Diretor, Executiva e Secretária. Encosto totalmente revestido nos modelos 7000.



ASSENTO

Assento em espuma injetada com Regulagem de Altura à Gás.



BASES

Base em Aço com Capa ou base Elíptica Cromada (modelos 7000). Rodízios em Nylon ou PU.



MECANISMOS

Modelos 3000 e 6000 com mecanismo padrão Relax com opção de Regulagem de Altura do Encosto ou Synchron com Regulagem de Altura do Encosto. Relax sem Regulagem de Altura do Encosto para o modelo 7000.



BRAÇOS

Modelos reguláveis nas opções SL, SL New PU, 2D e 3D. Modelos fixos nas opções Americano, Corsa, Style ou Théta (7000).



ESTRUTURAS

Estrutura fixa nas opções Arco (A), Palito (P), Balanço (S) ou Elíptica (modelo 7000). Acabamento Cromado ou Pintura em Preto.



CONFIGURAÇÕES



3001
Presidente Giratória
Relax
Braço SL



3002
Diretor Giratória
Relax
Braço SL



3006 S
Diretor Aproximação
Estrutura S
Braço Americano



3004 SRE
Secretária Giratória
Sistema Reclinador de Encosto
Braço SL New PU



L2048
Regulagem
de Altura
do Encosto



3008 S
Secretária Aproximação
Estrutura S



3022
Secretária Caixa
L2048 com Regulagem



3005
Diretor Longarina
Braço Americano Duplo



3009
Secretária Longarina



6001
Presidente Giratória
Relax
Braço SL



6002
Diretor Giratória
Relax
Braço SL



6006 S
Diretor Aproximação
Estrutura S
Braço Style



6104 SRE
Executiva Giratória
Sistema Reclinador de Encosto
Braço SL New PU



7001
Presidente Giratória
Relax
Braço Théta



7002
Diretor Giratória
Relax
Braço Théta



7006
Diretor Aproximação
Estrutura Elíptica
Braço Théta

DESENHOS TÉCNICOS

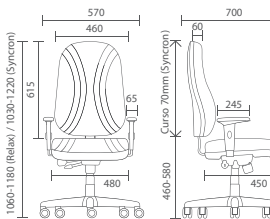

3001 Presidente Giratória

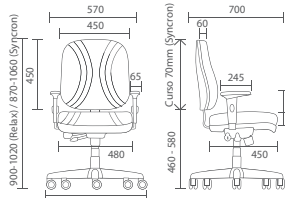

3002 Diretor Giratória

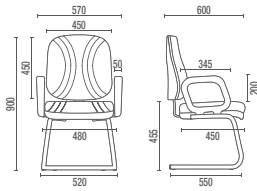

3006 S Diretor Aproximação

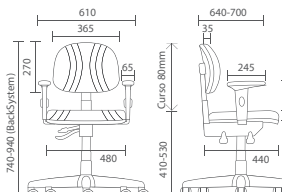

3004 Secretária Giratória

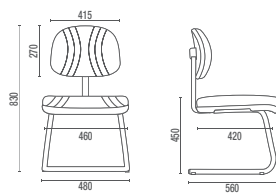

3008 S Secretária Aproximação

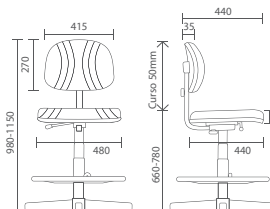

3022 SRE Secretária Caixa

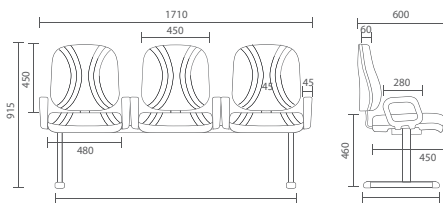

3005 Diretor Longarina

Largura Braço Duplo: 2L – 1146mm
 4L – 2300mm
 5L – 2875mm

Largura Braço Intercalado: 2L – 1092mm
 4L – 2138mm
 5L – 2660mm

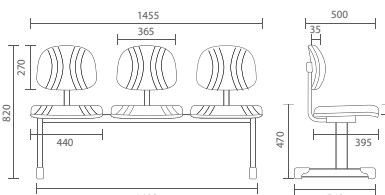

3009 Secretária Longarina

Largura sem Braço: 2L – 1010mm
 4L – 2070mm
 5L – 2600mm

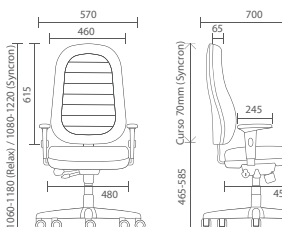

6001 Presidente Giratória

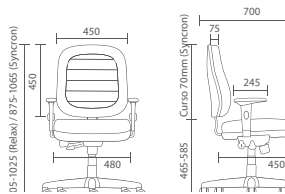

6002 Diretor Giratória

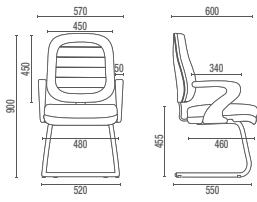

6006 S Diretor Aproximação

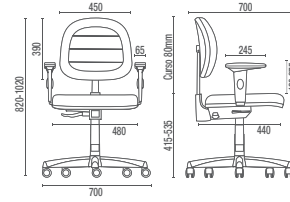

6104 Executiva Giratória

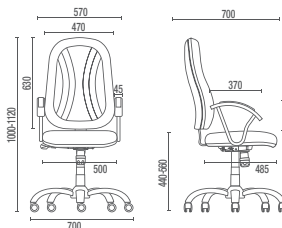

7001 Presidente Giratória

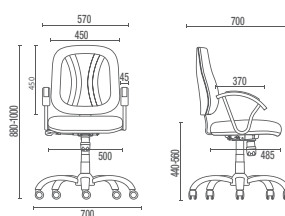

7002 Diretor Giratória

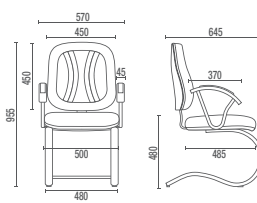

7006 Diretor Aproximação



Cavaletti - Fábrica e Showroom
 Rua Dr. Hiram Sampaio, 550
 Erechim/RS Brasil 99.700-000
 Fone/Fax: (54) 3520.4100
 atendimento@cavaletti.com.br
 www.cavaletti.com.br







Cavaletti Stilo

Equipada com Sistema Reclinador de Encosto (SRE) Original Cavaletti, a linha Stilo oferece uma série de regulagens ergonômicas ideais para permitir longas jornadas de trabalho com postura adequada, reduzindo o desgaste físico. Seu tamanho compacto ocupa apenas o espaço necessário, facilitando a movimentação intensa do dia-a-dia.

CARACTERÍSTICAS



REVESTIMENTOS
Diferentes opções de revestimento:
Poliéster, Vinil, Couro Ecológico
e Space.

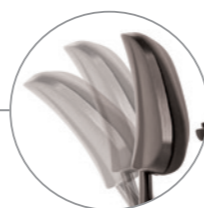

MECANISMOS
Sistema de Reclinação do Encosto
(SRE) e regulagem automática
de altura. Opção de Regulagem
de Altura também por manipulo
(L2048).



ASSENTO
Assento em espuma
injetada com Regulagem
de Altura à Gás.



BRAÇOS
Modelos giratórios com Braços
Reguláveis SL, SL New PU ou 2D
(todos com opção de Regulagem
Lateral) ou 3D. Braços Fixos nas
opções Americano, Corsa ou Style.



BASES
Bases em Aço com Capa.
Rodízios em Nylon ou PU.



ESTRUTURAS
Estrutura fixa nas opções Arco
(A), Palito (P) ou Balanço (S).
Acabamento com pintura
Prata ou Preto Liso Semi-Brilho.



CONFIGURAÇÕES



8203 SRE
Executiva Giratória
Sistema Reclinador de Encosto
Braço SL New PU



8203
Executiva Giratória
Flange
Braço SL New PU
Suporte de Encosto L2048



L2048
Regulagem
de Altura
do Encosto



8207 S
Executiva Aproximação
Estrutura S



8223
Executiva Caixa
Suporte do Encosto L2048



8210
Executiva Longarina

DESENHOS TÉCNICOS

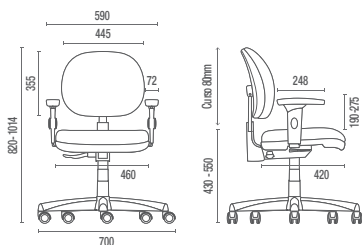

8203 SRE Executiva Giratória

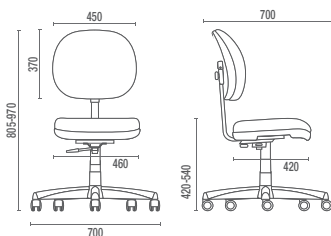

8203 Executiva Giratória

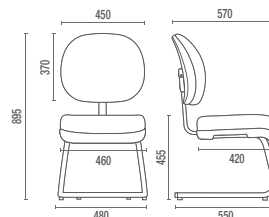

8207 S Executiva Aproximação

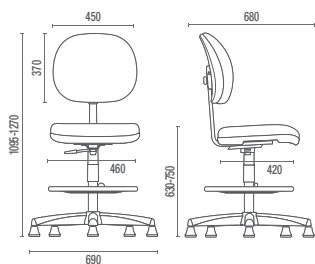

8223 Executiva Caixa

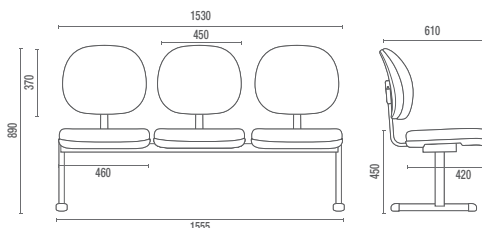

8210 Executiva Longarina



Cavaletti - Fábrica e Showroom
Rua Dr. Hiram Sampaio, 550
Erechim/RS Brasil 99.700-000
Fone/Fax: (54) 3520.4100
atendimento@cavaletti.com.br
www.cavaletti.com.br



Cavaletti

CADEIRAS PROFISSIONAIS



Cavaletti Slim



Cavaletti Slim

Com Design Original Cavaletti, a linha Slim possui encosto e assento com curvaturas anatômicas, mecanismo Sincron com quatro posições de travamento, opção de bases de aço ou alumínio e braços com movimentos 3D. Além de ser uma linha corporativa completa, seu desenho minimalista faz com que a Slim esteja pronta para integrar projetos mais contemporâneos.

CARACTERÍSTICAS



ACABAMENTOS

Diferentes opções de revestimento:
Poliéster, Vinil, Space, Couro
Ecológico e Couro Natural.



MECANISMOS

Mecanismo Sincron 2:1 com 4
opções de travamento, Sistema
Reclinador de Encosto ou Relax.



ASSENTO

Assento em espuma em alta
performace com Regulagem
de Altura à Gás.



BRAÇOS

Modelos giratórios com Braços
Reguláveis SL, SL New PU ou 2D,
todos com opção de Regulagem
Lateral, ou 3D. Modelos fixos
com braços integrados à estrutura.



BASES

Bases em Alumínio, Nylon,
Estampada ou Aço com Capa.
Rodízios em Nylon ou PU.



ESTRUTURA

Estrutura fixa com Braços
Integrados nas opções Balanço (S),
Z com Rodízios ou Z sem Rodízios.
Acabamento Cromado ou Preto
Ultrafosco Microtexturizado.



CONFIGURAÇÕES



18001
Presidente Giratória
Sincron
Braço SL
Base Alumínio



18002
Diretor Giratória
Sincron
Braço SL
Base Estampada



18004 SRE
Executiva Giratória
Sistema Reclinador de Encosto
Braço SL
Base Nylon



18006 Z ROD
Diretor Aproximação
Estrutura Z com Rodízios
Braços Integrados



18006 Z
Diretor Aproximação
Estrutura Z
Braços Integrados



18006 P
Diretor Aproximação
Estrutura P
Braços Integrados



18006 S
Diretor Aproximação
Estrutura S
Braços Integrados



18007 S
Secretária Aproximação
Estrutura S
Braços Integrados



18010
Diretor Longarina
Braço Z Intercalado

DESENHOS TÉCNICOS

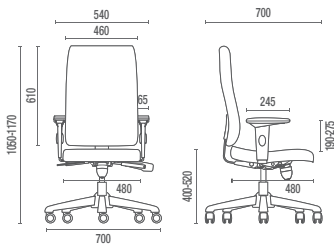

18001 **Presidente Giratória**

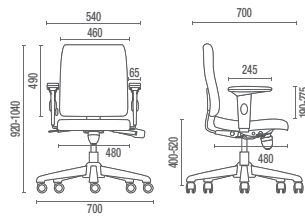

18002 **Diretor Giratória**

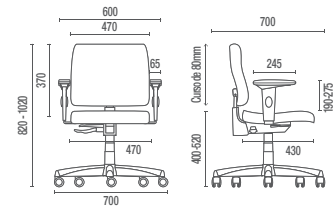

18004 SRE **Executiva Giratória**

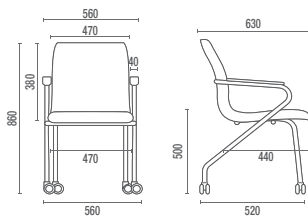

18006 Z ROD **Aproximação Giratória**

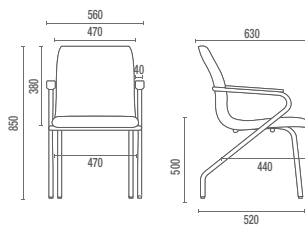

18006 Z **Aproximação Fixa**

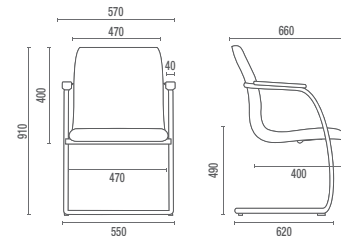

18006 S **Diretor Aproximação**

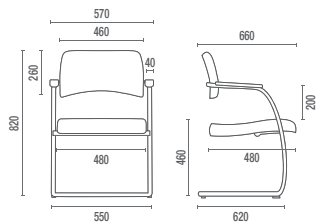

18007 S **Secretária Aproximação**

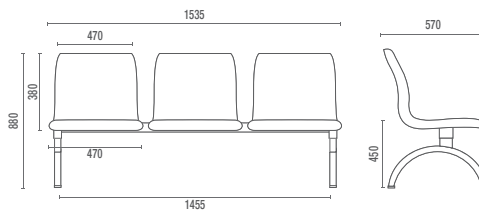

18010 **Longarina**

Larguras sem Braço: Larguras com Braço:
 2L – 1000mm 2L – 1080mm
 4L – 2070mm 4L – 2110mm
 5L – 2605mm 5L – 2625mm



Cavaletti - Fábrica e Showroom
 Rua Dr. Hiram Sampaio, 550
 Erechim/RS Brasil 99.700-000
 Fone/Fax: (54) 3520.4100
 atendimento@cavaletti.com.br
 www.cavaletti.com.br



Cavaletti

CADEIRAS PROFISSIONAIS



Cavaletti PRO



Cavaletti Pro

Espaços de trabalho dinâmicos pedem assentos confortáveis, práticos e duráveis, que se integrem à arquitetura de cada ambiente. Criada para atender áreas operativas e gerenciais, a linha Pro oferece soluções para atender de forma inteligente uma grande variedade de usuários, com alto índice de conforto e funcionalidade.

CARACTERÍSTICAS

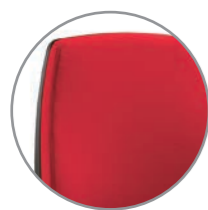

REVESTIMENTOS

Tecidos selecionados com costuras duplas nas opções: Poliéster, Space ou Couro Ecológico.



ESPALDAR

Espaldares Alto e Médio com curvaturas anatômicas para maior suporte da coluna vertebral.



MECANISMOS

Mecanismo Synchron ou Sistema Reclinador de Encosto (SRE), ambos com regulagem de altura do encosto, ou Relax.



BRAÇOS

Modelos giratórios com Braços Reguláveis SL, SL New PU ou 2D (todos com opção de Regulagem Lateral) ou 3D. Modelos fixos com Braços Integrados.

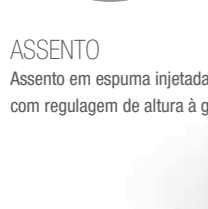

ASSENTO

Assento em espuma injetada com regulagem de altura à gás.



BASES

Bases em Alumínio, Nylon ou Aço com Capa. Rodízios em Nylon ou PU.



ESTRUTURA

Bases fixas na opção Balanço com ou sem Braços Integrados (S ou SI) e Sapata Estabilizadora. Acabamento Cromado ou Preto Ultrafosco Microtexturizado.

CONFIGURAÇÕES



38001 SRE
Operacional Alta
Sistema Reclinador do Encosto
Braço SL
Base Aço com Capa



38006 SI
Alta Aproximação Alta
Estrutura SI
Braços Integrados



38006 S
Aproximação Alta
Estrutura S



38003 SRE
Operacional Média
Sistema Reclinador do Encosto
Braço SL
Base Aço com Capa



38006 SI
Aproximação Média
Estrutura SI
Braços Integrados



38007 S
Aproximação Média
Estrutura S



38022 SRE
Caixa Média
Sistema Reclinador do Encosto
Braço SL
Base Aço com Capa



38010
Longarina Média

DESENHOS TÉCNICOS

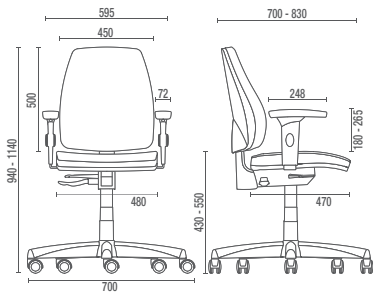

38001 SRE Operacional Alta

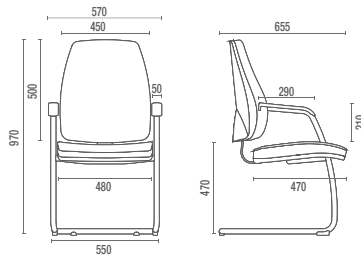

38006 SI Aproximação Alta com Braços Integrados

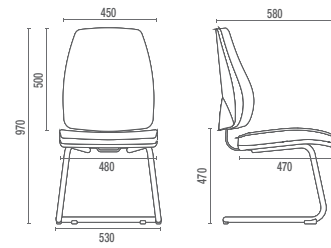

38006 S Aproximação Alta

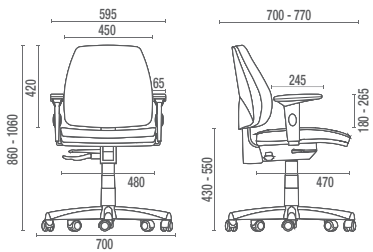

38003 SRE Operacional Média

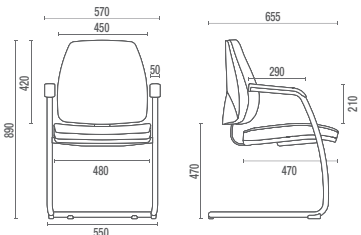

38007 SI Aproximação Média com Braços Integrados

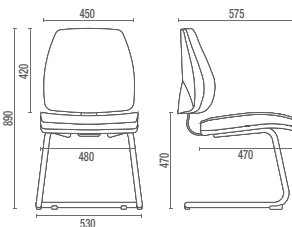

38007 S Aproximação Média

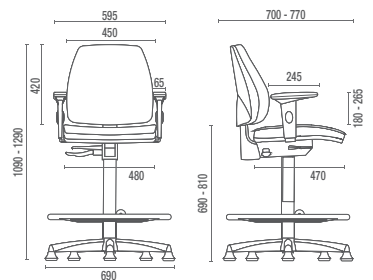

38022 SRE Caixa Média

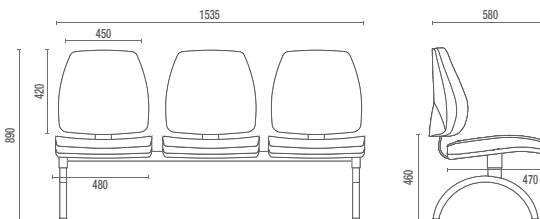

38010 Longarina Média

Larguras:
2L - 1010mm
4L - 2070mm
5L - 2600mm

Cavaletti®

CADEIRAS PROFISSIONAIS



Cavaletti Mais

Cavaletti Mais

A linha Mais oferece design centrado no essencial, adaptando-se a diversos estilos de ambientes. Desenvolvida utilizando conceitos ergonômicos e engenharia de ponta, a Mais dispõe de produtos funcionais e de uso prático, facilitando a busca pela postura de trabalho ideal de forma simples sem complicações.



CARACTERÍSTICAS



REVESTIMENTOS
Revestimentos disponíveis nos tecidos Poliéster, Space ou Couro Ecológico.

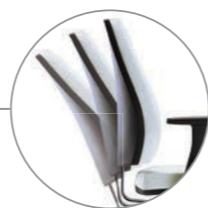

MECANISMOS
Sincron ou Sincron RP com regulagem de altura do encosto, Relax com flutuação livre ou Plataforma Giratória com regulagem de altura.

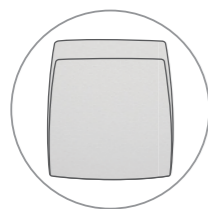

ESPALDAR
Espaldares Alto e Médio com curvaturas anatômicas para melhor o suporte da coluna vertebral.



BRAÇOS
Modelos giratórios com Braços Reguláveis SL, SL New PU ou 2D (todos com opção de Regulagem Lateral) ou 3D. Modelos fixos com Braços Integrados.



ASSENTO
Assento em espuma injetada com Regulagem de Altura à Gás.



BASES
Bases giratórias em Alumínio Polido, Nylon e Aço com Capa. Rodízios de 50mm ou 60mm em Nylon ou PU.



ESTRUTURA
Base fixa em estrutura Balanço com Braço Integrado (SI) e Sapata Fixa. Acabamento Cromado ou Preto Fosco Microtexturizado.

CONFIGURAÇÕES



37001
Giratória Alta
Sincron
Braço 3D
Base Alumínio



37001
Giratória Alta
Sincron
Braço 3D
Base Nylon



37002
Giratória Média
Sincron
Braço SL New PU
Base Nylon



37006
Aproximação Média
Estrutura SI
Braços Integrados

DESENHOS TÉCNICOS

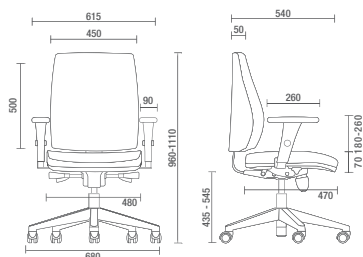

37001 Operacional Alta

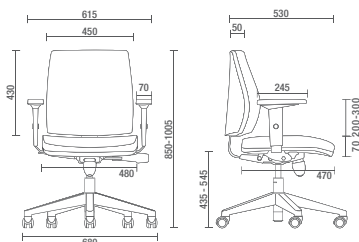

37002 Operacional Média

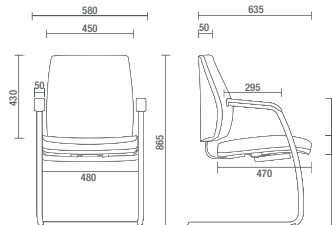

37006 SI Aproximação Média

©Copyright 2014 Cavaletti S/A - Todos os direitos reservados. A Cavaletti S/A reserva-se o direito de alterar produtos a qualquer tempo e sem aviso prévio. Alguns itens são opcionais e podem não fazer parte do produto básico. SET/2014 V1 tiragem 5.000.

R4DESIGN



Cavaletti - Fábrica e Showroom
Rua Dr. Hiram Sampaio, 550
Erechim/RS Brasil 99.700-000
Fone/Fax: (54) 3520.4100
atendimento@cavaletti.com.br
www.cavaletti.com.br



Cavaletti®

CADEIRAS PROFISSIONAIS



Cavaletti Air



Cavaletti Air

Os produtos da linha Air se adaptam às formas e necessidades do ser humano. Com ajustes projetados para oferecer excelente ergonomia e conforto para uso intenso, a Air oferece opções de regulagens individuais como altura do apoio lombar e profundidade do assento, que ampliam sensivelmente o suporte e as áreas de sustentação corporal, adaptando-se de acordo com a constituição física de cada usuário.

CARACTERÍSTICAS



ACESSÓRIOS

Apoio Lombar Regulável integrado ao encosto, permite ajuste vertical de 50 mm de curso. Melhor suporte de base da coluna vertebral.

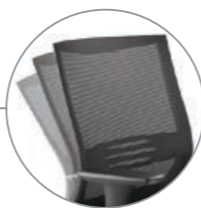

MECANISMO

Synchron 2.1: movimento sincronizado entre assento e encosto com 4 posições de tratamento ou livre flutuação.

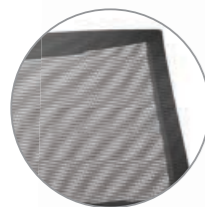

ESPALDAR

Estrutura em plástico injetado de alta resistência e apoio em tela tipo *mesh*. Disponível nas cores Preto e Cinza.



BRAÇOS

Modelos giratórios com Braços Reguláveis SL, SL New PU ou 2D (todos com opção de Regulagem Lateral) ou 3D. Braços Integrados nos modelos fixos.



BASES

Bases giratórias em Alumínio, Nylon ou Aço com Capa. Acabamentos adequados para cada tipo de ambiente. Rodízios 50mm ou 60mm em Nylon ou PU.



ASSENTO

Em espuma alta performance e tecido Poliéster com Regulagem de Altura à Gás e opção de Regulagem de Profundidade.

CONFIGURAÇÕES



27001
Poltrona Giratória
Synchron RP
Apoio Lombar Regulável
Braço 3D
Base Alumínio



27001
Poltrona Giratória
Synchron RP
Apoio Lombar Regulável
Braço 3D
Base Nylon



27006 SI
Poltrona Aproximação
Estrutura SI
Braços Integrados



27006 SI
Poltrona Aproximação
Estrutura SI
Braços Integrados

CORES TELA

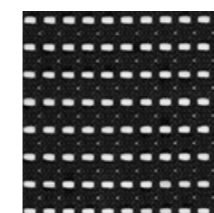

Preto

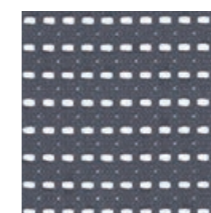

Cinza

DESENHOS TÉCNICOS

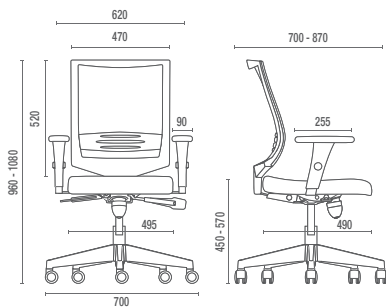

27001 Poltrona Giratória

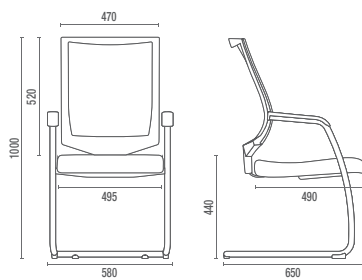

27006 SI Poltrona Aproximação



Cavaletti - Fábrica e Showroom
 Rua Dr. Hiram Sampaio, 550
 Erechim/RS Brasil 99.700-000
 Fone/Fax: (54) 3520.4100
 atendimento@cavaletti.com.br
 www.cavaletti.com.br



®

Cavaletti

CADEIRAS PROFISSIONAIS



Cavaletti NewNet

Cavaletti NewNet

A linha NewNet oferece a experiência única proporcionada pelo encosto em tela. Desenvolvido para adaptar-se continuamente à curvatura da coluna e oferecer maior apoio, este material também proporciona melhor ventilação natural quando em uso.

A NewNet Soft é resultado da união da tela de dupla membrana com a flexibilidade das cores e materiais de revestimento, unindo a ergonomia proporcionada pela tela à variedade de acabamentos de uma cadeira estofada, em design sofisticado e único.



CARACTERÍSTICAS



ACESSÓRIOS
Opção de Apoio para a Cabeça disponível para os modelos 16001 e 16501.



MECANISMOS
Mecanismo Sincron, Sistema Reclinador de Encosto (SRE) ou Plataforma Giratória sem Relax conforme modelo.



REVESTIMENTOS
Diferentes opções de revestimento para assento NewNet ou assento e encosto NewNet Soft: Poliéster, Space e Couro Ecológico.

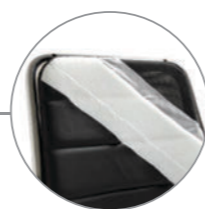

ENCOSTO
Tela de dupla membrana (modelos 16000) com opção de revestimento para NewNet Soft (modelos 16500).



ASSENTO
Assento em espuma injetada com Regulagem de Altura à Gás.



BRAÇOS REGULÁVEIS
Modelos giratórios com braço SL, SL New PU, 2D ou 3D.

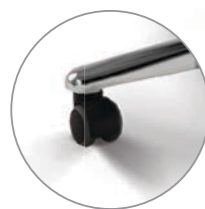

BASES
Bases em Alumínio, Nylon ou Estampada. Rodízios de 50 ou 60mm em Nylon ou PU.



ESTRUTURA
Estrutura fixa Balanço (S) com opções de acabamentos cromado e preto ultrafosco texturizado.

CONFIGURAÇÕES

NEUNET



16001 AC
Presidente Giratória
Sincron
Braço 3D
Base Alumínio



16001
Presidente Giratória
Sincron
Braço 3D
Base Estampada



16002
Diretor Giratória
Sincron
Braço 3D
Base Nylon



16003 SRE
Executiva Giratória
Sistema Reclinador do Encosto
Braço SL
Base Nylon



16006 S
Executiva Aproximação
Estrutura S
Braços Integrados



16010
Longarina Executiva
L2048 Fixo
Braço Corsa Intercalado



16010
Longarina Executiva
L2048 Fixo

NEUNET SOFT



16501 AC
Presidente Giratória
Sincron
Braço 3D
Base Alumínio



16501
Presidente Giratória
Sincron
Braço 3D
Base Estampada



16503 SRE
Executiva Giratória
Sistema Reclinador de Encosto
Braço SL New PU
Base Estampada



16506 S
Executiva Aproximação
Estrutura S
Braços Integrados

DESENHOS TÉCNICOS

NEWNET

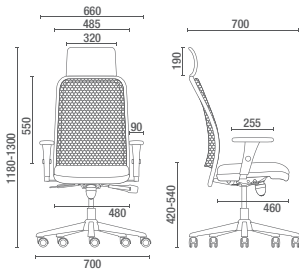

16001 AC Presidente Giratória

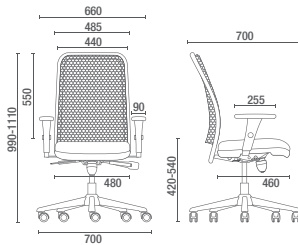

16001 Presidente Giratória

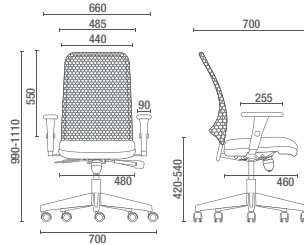

16002 Diretor Giratória

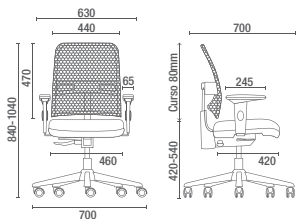

16003 SRE Executiva Giratória

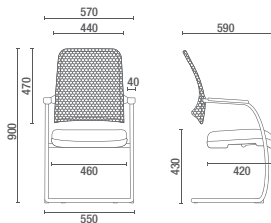

16006 S Executiva Aproximação

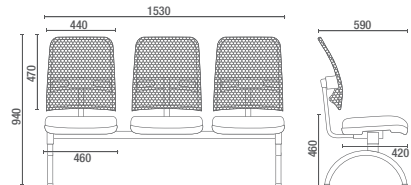

16010 Longarina Executiva

NEWNET SOFT

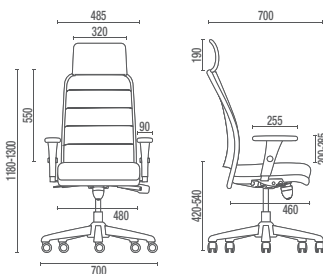

16501 AC Presidente Giratória

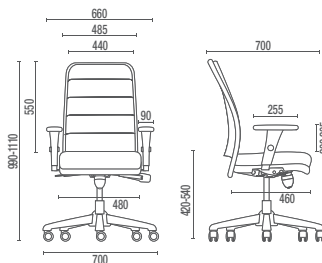

16501 Presidente Giratória

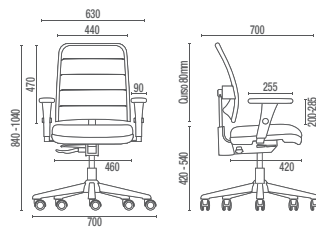

16503 SRE Executiva Giratória

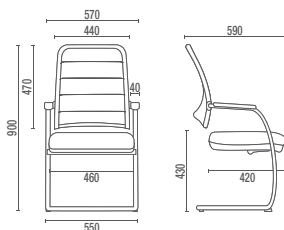

16506 S Executiva Aproximação



Cavaletti - Fábrica e Showroom
Rua Dr. Hiram Sampaio, 550
Erechim/RS Brasil 99.700-000
Fone/Fax: (54) 3520.4100
atendimento@cavaletti.com.br
www.cavaletti.com.br



DIRETIVAS



Cavaletti®

CADEIRAS PROFISSIONAIS



Cavaletti Essence.



Cavaletti Essence

Em um ambiente diretivo, essencial é reunir em um único produto, acabamentos refinados, dimensões generosas e ajustes ergonômicos para garantir amplo conforto em todas as decisões do dia.

CARACTERÍSTICAS



ESPALDAR
Espaldar com 770mm nos modelos Presidente. Maior dimensão entre os produtos Cavaletti.

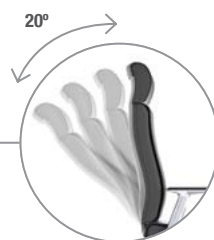

MECANISMOS
Mecanismo Synchron de 4 estágios com regulagem de tensão por manípulo central.

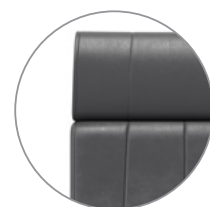

REVESTIMENTOS
Disponível em CEC ou 100% Couro Natural (COU).



BRAÇOS
Braços exclusivos, fixos em alumínio ou 4D em Nylon (Regulagem em altura, profundidade, afastamento lateral e rotação do apoio). Pad em PU Soft touch.

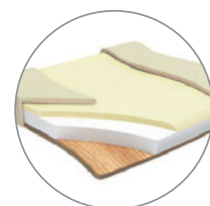

SUPORTE
Assento com três densidades de espuma, distribuídas conforme a área de apoio.



ASSENTO
Assento com Regulagem de Profundidade e Regulagem de Altura à Gás.



BASES
Opção de bases em Alumínio ou Nylon. Rodízios de 65mm em Nylon ou PU.



ESTRUTURAS
Base fixa com rodízios frontais para melhor movimentação. Acabamento cromado ou ultrafosco microtexturizado.

CONFIGURAÇÕES



20.501
Presidente Giratória
Synchron RP
Braços fixos em Alumínio
Base Alumínio



20.502
Diretor Giratória
Synchron RP
Braços fixos em Alumínio
Base Alumínio



20.506 S
Diretor Aproximação
Estruturas com rodízios frontais
Braços fixos em Alumínio



Mobilidade
Rodízios frontais



20.501
Presidente Giratória
Synchron RP
Braços 4D
Base Nylon



20.502
Diretor Giratória
Synchron RP
Braços 4D
Base Nylon



20.506 S
Diretor Aproximação
Estruturas com rodízios frontais
Braços 4D

REVESTIMENTOS

Couro Natural (COU)

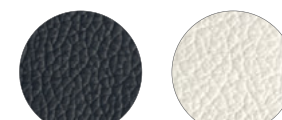

Preto Branco



Marrom

CEC



Preto Cinza Branco Bege Fendi



Vermelho

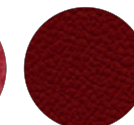

Vinho
NOVO



Marrom



Verde
NOVO



Azul
NOVO

DESENHOS TÉCNICOS

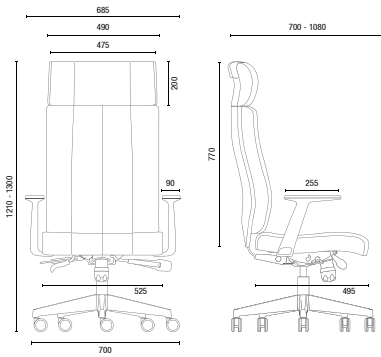

20.501 Presidente Giratória
Braços fixos em Alumínio

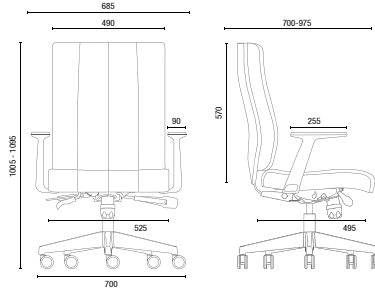

20.502 Diretor Giratória
Braços fixos em Alumínio

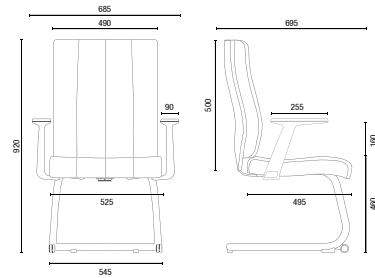

20.506 S Diretor Aproximação
Braços fixos em Alumínio

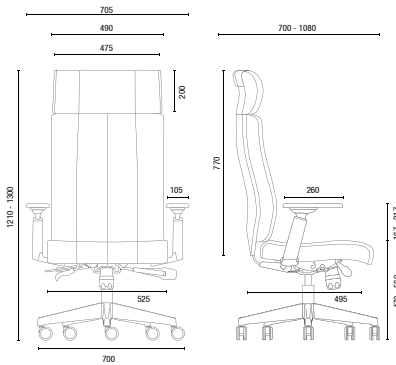

20.501 Presidente Giratória
Braços 4D

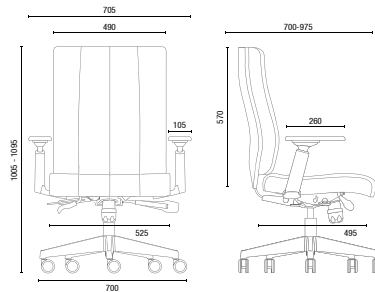

20.502 Diretor Giratória
Braços 4D

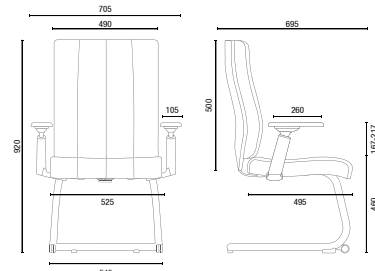

20.506 S Diretor Aproximação
Braços 4D

OBS: Medidas extremas obtidas sem o uso de gabarito de carga.



Cavaletti - Fábrica e Showroom
Rua Dr. Hiram Sampaio, 550
Erechim/RS Brasil 99.706-461
Fone/Fax: (54) 3520.4100
atendimento@cavaletti.com.br
www.cavaletti.com.br





Cavaletti[®]

CADEIRAS PROFISSIONAIS

Cavaletti Way

Cavaletti Way

A linha Cavaletti Way oferece design inspirado nas silhuetas esbeltas, elegantes e com personalidade marcante. Apresenta três opções de altura de espaldar para atender todos os tipos de ambientes diretivos.



APOIO DE CABEÇA
Maior suporte da região cervical (modelo 19001 L).

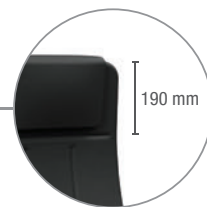

ESPALDAR
Espaldar 190 mm mais alto. Suporte interno em tela em todos os modelos.

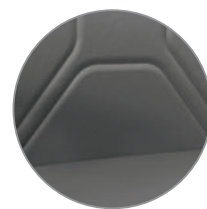

DETALHES
Costura com desenho exclusivo.



BRAÇOS AJUSTÁVEIS
Opção de braços SL, SL New PU, reguláveis em altura. Braço 3D com ajuste de altura, avanço e ângulo do apoio PU.



MECANISMO
Mecanismo Synchron que permite movimento sincronizado do assento e espaldar na proporção 2:1.



BASES E ESTRUTURAS
Estrutura fixa balanço com braços integrados (SI). Acabamento em pintura Preto Ultra Fosco Microtexturizado e Cromado.

CONFIGURAÇÕES



19001 L
Presidente Giratória L
Synchron
Braços 3D
Base Alumínio
Apoio de Cabeça



19001
Presidente Giratória
Synchron
Braços SL New PU
Base Alumínio



19002
Diretor Giratória
Synchron
Braços 3D
Base Alumínio



19006 SI
Diretor Aproximação
Estrutura SI
Braços Integrados

DESENHOS TÉCNICOS

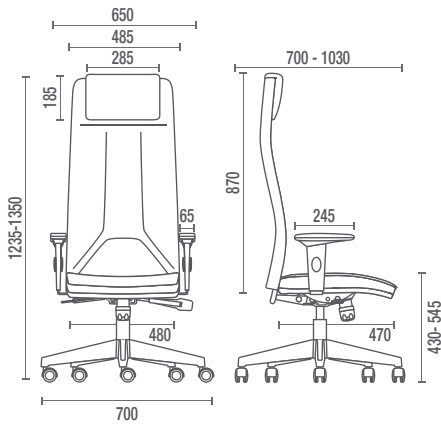

19001 L **Presidente Giratória L**

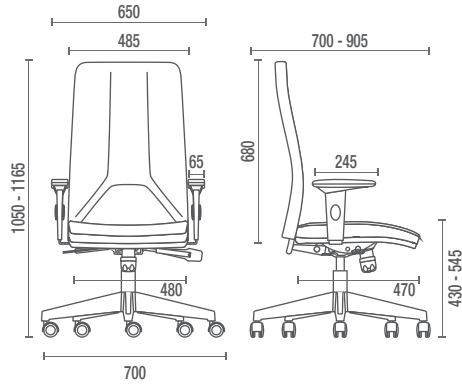

19001 **Presidente Giratória**

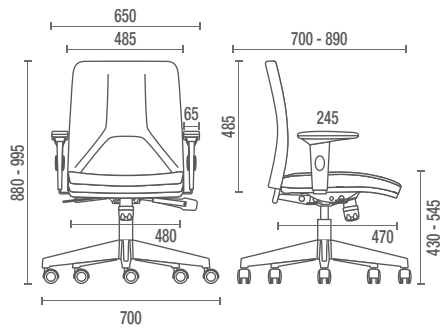

19002 **Diretor Giratória**

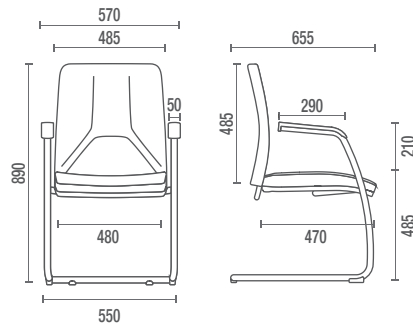

19006 SI **Diretor Aproximação**



Cavaletti - Fábrica e Showroom
 Rua Dr. Hiram Sampaio, 550
 Erechim/RS Brasil 99.700-000
 Fone/Fax: (54) 3520.4100
 atendimento@cavaletti.com.br
 www.cavaletti.com.br





Cavaletti®

CADEIRAS PROFISSIONAIS

Cavaletti C3

Cavaletti C3

Simplicidade e ergonomia. Atributos essenciais de uma cadeira para espaços de trabalho de alta exigência, onde a alta performance é o objetivo mais importante.



CARACTERÍSTICAS



ACESSÓRIOS
Opção de Apoio de Cabeça com regulagem de altura automática e movimentos 3D permitindo melhor ajuste e acomodação. Disponível em Preto.



MECANISMOS
Mecanismo Sincron de 4 estágios com regulagem automática da tensão, ajustando-se ao peso do usuário sem a necessidade de ajuste manual.



ESPALDAR
Espaldar em tela preta com Apoio Lombar flexível e regulável.



BRAÇOS
Braços 4D, reguláveis em altura, movimento horizontal frontal, lateral e giro no plano horizontal. Apoio em PU *soft touch*.



BASES
Bases em Alumínio ou Nylon com rodízios de 60mm ou 50mm. Base em Aço com Capa com rodízios de 50mm. Rodízios em Nylon ou PU.



ASSENTO
Assento em espuma injetada com Regulagem de Profundidade e Regulagem de Altura à Gás. Revestimento em Poliéster ou Space.

DESENHOS TÉCNICOS

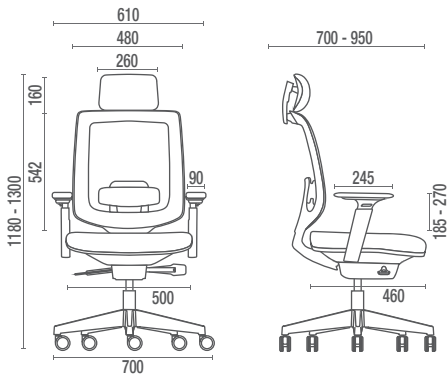

28001 AC **Presidente Giratória com Apoio de Cabeça**

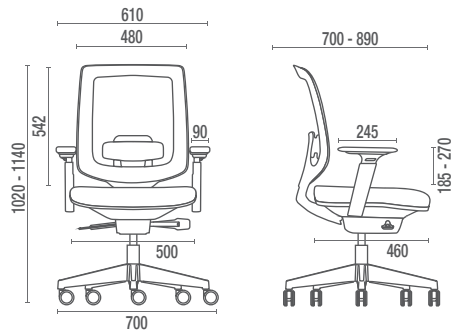

28001 **Presidente Giratória**



Cavaletti - Fábrica e Showroom
 Rua Dr. Hiram Sampaio, 550
 Erechim/RS Brasil 99.700-000
 Fone/Fax: (54) 3520.4100
 atendimento@cavaletti.com.br
 www.cavaletti.com.br



Cavaletti

CADEIRAS PROFISSIONAIS



Cavaletti C4

Cavaletti C4

Funções ergonômicas avançadas e acabamento com detalhes em alumínio fazem da Cavaletti C4 uma alternativa ideal para espaços diretivos de alto padrão.



ACESSÓRIOS
Opção de Apoio de Cabeça.
Disponível em Preto.



MECANISMOS
Mecanismo Synchron de 4 estágios com regulagem automática da tensão, ajustando-se ao peso do usuário sem a necessidade de ajuste manual.



ESPALDAR
Espaldar em tela, com Apoio Lombar estofado e regulável. Estrutura aparente em Alumínio Polido.



BRAÇOS
Braços 3D, reguláveis em altura, movimento horizontal frontal ou lateral. Apoio em PU *soft touch*.



BASES
Opção de base em Alumínio ou Nylon, com rodízios de 60mm em PU ou Nylon.



ASSENTO
Assento em espuma injetada com Regulagem de Profundidade e Regulagem de Altura à Gás. Revestimento em Poliéster ou Space.



29001
Presidente Giratória
Synchron
Braços 3D
Base em Nylon



29001 AC
Presidente Giratória
Synchron
Braços 3D
Base em Alumínio
Apoio de Cabeça

DESENHOS TÉCNICOS

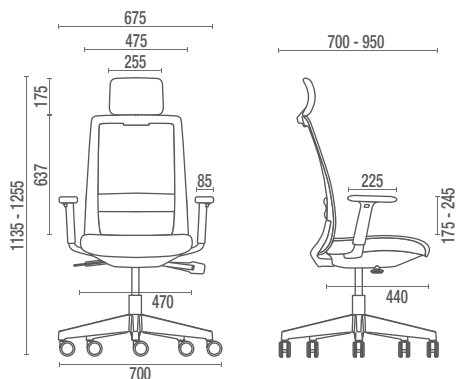

29001 AC **Presidente Giratória com Apoio de Cabeça**

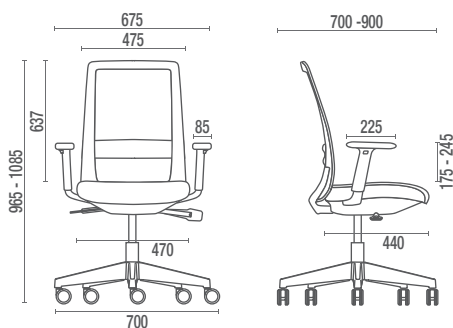

29001 **Presidente Giratória**



Cavaletti - Fábrica e Showroom
 Rua Dr. Hiram Sampaio, 550
 Erechim/RS Brasil 99.700-000
 Fone/Fax: (54) 3520.4100
 atendimento@cavaletti.com.br
 www.cavaletti.com.br





Cavaletti®

CADEIRAS PROFISSIONAIS

Cavaletti Chroma

Cavaletti Chroma

A linha Chroma apresenta beleza do couro 100% natural associada à leveza dos cromados por meio de um design clássico e atemporal.



REVESTIMENTOS
Revestimento em Couro 100% Natural com quatro opções de cores.



MECANISMOS
Mecanismo Relax com reclinção livre.



ASSENTO
Assento com proteção na parte inferior, evitando que o couro fique marcado. Regulagem de Altura à gás.



BRAÇOS
Braços integrados à estrutura, que proporcionam maior solidez construtiva e durabilidade.



BASES
Base Estampada ou Elíptica com acabamento Cromado. Rodízios em Nylon ou PU.



ESTRUTURA
Estrutura fixa Balanço (S) com acabamento Cromado.



CONFIGURAÇÕES



14001
Presidente Giratória
Relax
Braços Integrados
Base Elíptica



14001
Presidente Giratória
Relax
Braços Integrados
Base Estampada



14004
Secretária Giratória
Mecanismo Fixo sem Relax
Braços Integrados
Base Elíptica



14007 S
Secretária Aproximação
Estrutura S
Braços Integrados

CORES

A linha Chroma oferece revestimento em Couro 100% Natural com quatro opções de cores: Marrom, Bege, Preto e Branco.

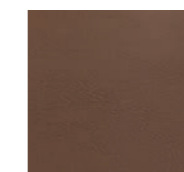

958
Marrom



977
Bege



991
Preto



995
Branco

DESENHOS TÉCNICOS

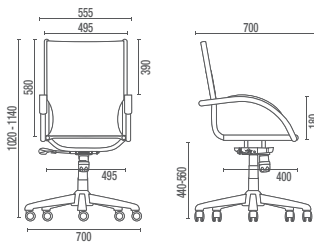

14001 **Presidente Giratória**

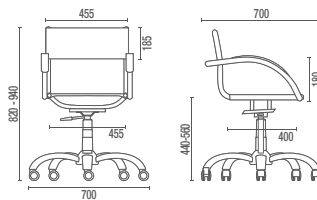

14004 **Secretária Giratória**

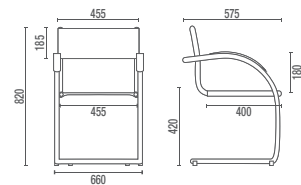

14007 S **Secretária Aproximação**



Cavaletti - Fábrica e Showroom
 Rua Dr. Hiram Sampaio, 550
 Erechim/RS Brasil 99.700-000
 Fone/Fax: (54) 3520.4100
 atendimento@cavaletti.com.br
 www.cavaletti.com.br





Cavaletti®

CADEIRAS PROFISSIONAIS

Cavaletti Master

Cavaletti Master

Reunindo conforto e estilo necessários para ambientes executivos, a linha Master é composta por poltronas fixas e giratórias revestidas em couro natural ou ecológico de alta qualidade.



REVESTIMENTOS
Duas opções de Couro para o revestimento: Natural ou Ecológico.



ESPALDAR
Mecanismo Relax com reclinção livre.



ASSENTO
Assento em espuma injetada especial com regulagem de altura à gás.



BRAÇOS
Braços Fixos Cromados com acabamento em PP Preto.



BASES
Base Elíptica ou Estampada com acabamento em Preto Ultrafosco Microtexturizado ou Cromado ou base em Alumínio. Rodízios em Nylon ou PU.



ESTRUTURAS
Estrutura fixa Balanço (S) ou Elíptica. Acabamento em Preto Ultrafosco Microtexturizado ou Cromado.

CONFIGURAÇÕES



20001
Presidente Giratória
Relax
Base Alumínio



20002
Diretor Giratória
Relax
Base Estampada



20006 S
Diretor Aproximação
Estrutura Balanço (S)



20006
Diretor Aproximação
Estrutura Elíptica

DESENHOS TÉCNICOS

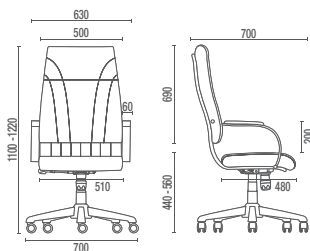

20001 **Presidente Giratória**

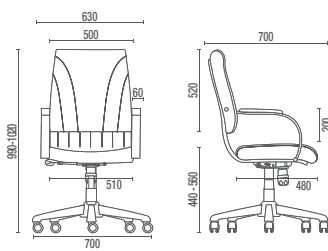

20002 **Diretor Giratória**

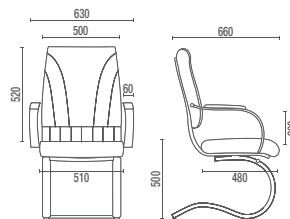

20006 **Diretor Aproximação**



Cavaletti - Fábrica e Showroom
 Rua Dr. Hiram Sampaio, 550
 Erechim/RS Brasil 99.700-000
 Fone/Fax: (54) 3520.4100
 atendimento@cavaletti.com.br
 www.cavaletti.com.br



Cavaletti

CADEIRAS PROFISSIONAIS



Cavaletti Prime

Cavaletti Prime

Ser prime é ter direito ao que há de melhor. Por isso, as poltronas para áreas diretivas da linha Prime são produzidas com atenção aos detalhes, utilizando materiais nobres e construção primorosa.



CONFIGURAÇÕES

PRIME 20200



20201
Presidente Giratória
Sincron Excêntrico
Braços Articuláveis
Base Alumínio



20202
Diretor Giratória
Sincron Excêntrico
Braços Articuláveis
Base Alumínio



20206 S
Diretor Aproximação
Estrutura S
Braços Articuláveis

PRIME 20100 E PRIME 20300



20101
Presidente Giratória
Relax
Braços Fixos
Base Estampada



20102
Diretor Giratória
Relax
Braços Fixos
Base Estampada



20103
Diretor Giratória Extra
Relax
Braços Fixos
Base Estampada



20106 S
Diretor Aproximação
Estrutura S
Braços Fixos



20301
Presidente Giratória
Relax
Braços Fixos com Apoio Estofado
Base Elíptica



20302
Diretor Giratória
Relax
Braços Fixos com Apoio Estofado
Base Elíptica



20306
Diretor Aproximação
Estrutura Elíptica
Braços Fixos com Apoio Estofado

CARACTERÍSTICAS



REVESTIMENTOS
Modelos com revestimento em Couro Natural.



MECANISMOS
Espaldares Presidente ou Diretor com Synchron Excêntrico.



BRAÇOS
Braços Articulados em Alumínio com apoio em PU.



BASES
Base em Alumínio com desenho exclusivo. Rodízios 50mm em Nylon ou PU.



PRIME 20200



ASSENTO
Assento com Regulagem de Altura à Gás em espuma multidensidade.



ESTRUTURA
Estrutura fixa nas opções Eliptica (exceto modelo 20206) ou Balanço (S) com acabamento Cromado.



PRIME 20100
PRIME 20300



REVESTIMENTOS
Revestimento em Couro Natural (modelos 20300) ou Couro Ecológico (modelos 20100) e duas opções de costuras conforme modelo.



MECANISMOS
Modelos Presidente e Diretor com ou sem Relax.



BRAÇOS
Braço Cromado com acabamento em PP (modelos 20100) ou Estofado (modelos 20300).



BASES
Bases em Alumínio, Estampada ou Eliptica. Rodízios 50mm em Nylon ou PU.

DESENHOS TÉCNICOS

PRIME 2020

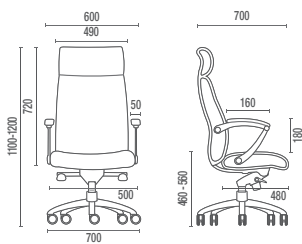

20201 Presidente Giratória

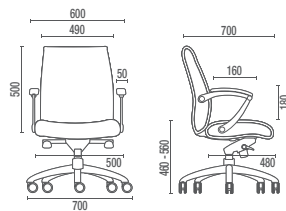

20202 Diretor Giratória

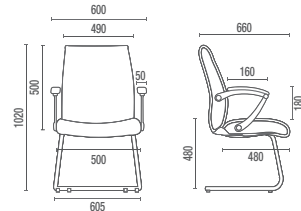

20206 Diretor Aproximação

PRIME 20100 E PRIME 20300

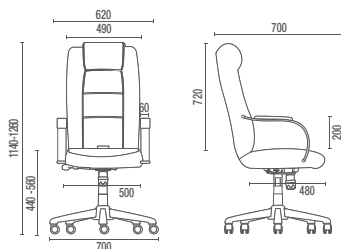

20101 Presidente Giratória

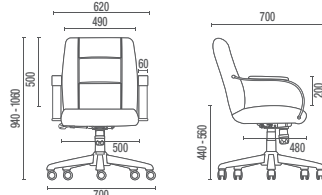

20102 Diretor Giratória

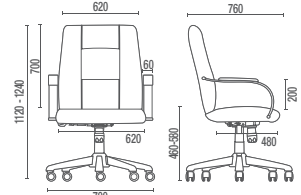

20103 Diretor Giratória Extra

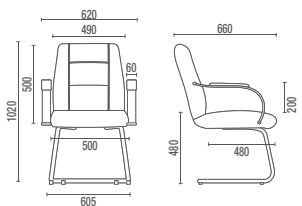

20106 S Diretor Aproximação

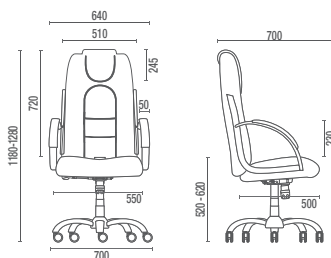

20301 Presidente Giratória

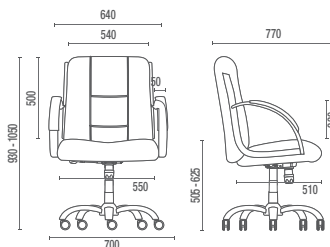

20302 Diretor Giratória

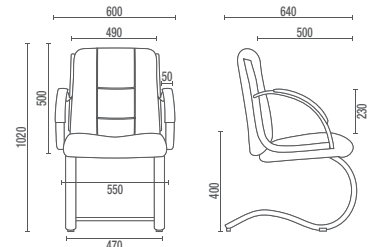

20306 Diretor Aproximação



Cavaletti - Fábrica e Showroom
Rua Dr. Hiram Sampaio, 550
Erechim/RS Brasil 99.700-000
Fone/Fax: (54) 3520.4100
atendimento@cavaletti.com.br
www.cavaletti.com.br



COLETIVAS

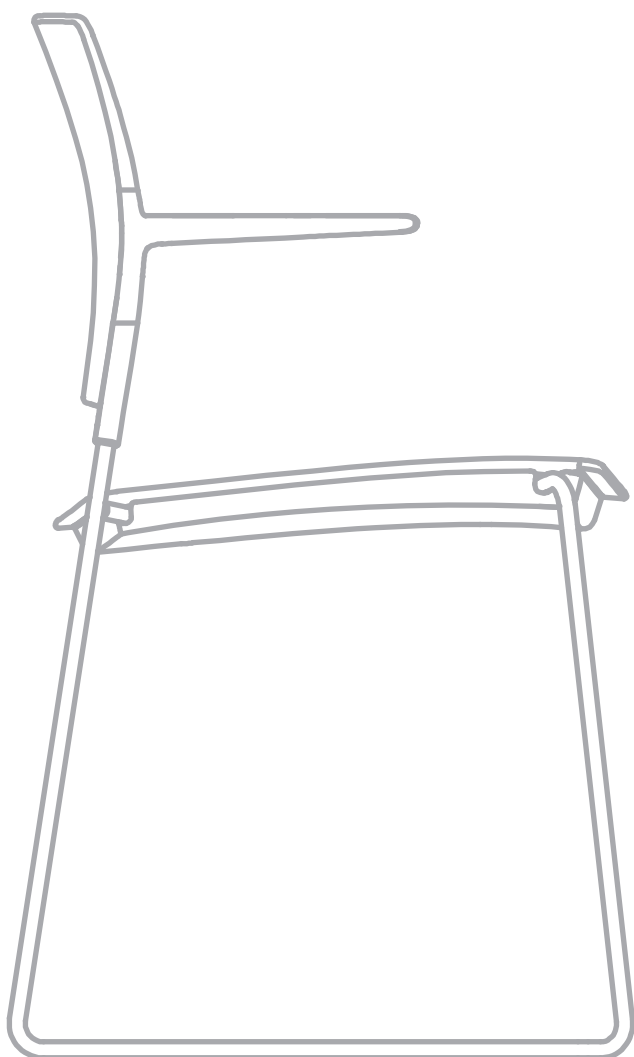

Cavaletti[®]

CADEIRAS PROFISSIONAIS



Cavaletti Joy



CARACTERÍSTICAS

Tem horas que tudo o que a gente precisa é descomplicar.



HANDLE
Design inteligente, permite praticidade no manuseio.



CLICKS
Sem parafusos. O sistema de montagem é todo por click.



PROTEÇÃO
Apoio para empilhamento com esperas em TPE.



EMPILHAMENTO
Empilhável até 10 unidades.

COMPOSIÇÕES



41.008
Branco Off
Plásticos Branco Off 44
Base Branco Off Ultrafosco
Opção de Base Cromada



41.008
Cinza
Plásticos Cinza 41
Base Prata Fosco
Opção de Base Cromada



41.008
Grafite
Plásticos Grafite 45
Base Grafite Ultrafosco
Opção de Base Cromada



41.008
Preto
Plásticos Cinza 41
Base Preto Ultrafosco
Opção de Base Cromada



41.008
Azul
Plásticos Azul Noite 32
Base Azul Ultrafosco
Opção de Base Cromada



41.008
Oliva
Plásticos Oliva 76
Base Oliva Ultrafosco
Opção de Base Cromada



41.008
Areia
Plásticos Areia 77
Base Areia Ultrafosco
Opção de Base Cromada



41.008
Telha
Plásticos Terracota 78
Base Telha Ultrafosco
Opção de Base Cromada



41.008
Amarelo
Plásticos Amarelo 16
Base Amarelo Ultrafosco
Opção de Base Cromada



41.008
Vermelho
Plásticos Vermelho Apple 43
Base Vermelho Ultrafosco
Opção de Base Cromada



Carrinho
Empilhamento máximo: 10 unidades

DESENHOS TÉCNICOS

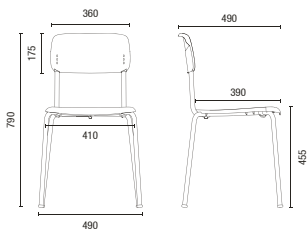

41.008 Aproximação

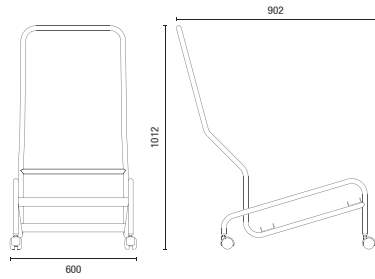

Carrinho
Empilhamento máximo: 10 unidades

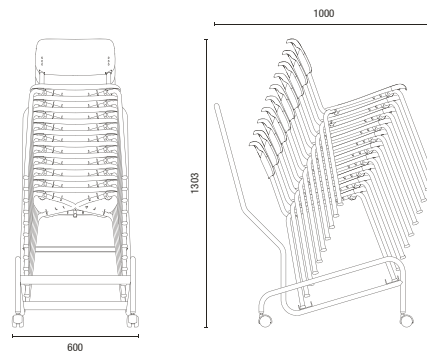

Carrinho
Empilhamento máximo: 10 unidades

ESTRUTURAS

| | Preto Ultrafosco | Prata Fosco | Cromado | Grafite Fosco | Vermelho | Telha | Amarelo | Areia | Oliva | Azul | Branco Off |
|-------------------|------------------|-------------|---------|---------------|----------|-------|---------|-------|-------|------|------------|
| Preto 06 | ● | ● | ● | | | | | | | | |
| Grafite 45 | ● | ● | ● | ● | | | | | | | |
| Vermelho Apple 43 | ● | ● | ● | | ● | | | | | | |
| Telha 78 | ● | ● | ● | | | ● | | | | | |
| Amarelo 16 | ● | ● | ● | | | | ● | | | | |
| Areia 77 | ● | ● | ● | | | | | ● | | | |
| Oliva 76 | ● | ● | ● | | | | | | ● | | |
| Azul Noite 32 | ● | ● | ● | | | | | | | ● | |
| Cinza 41 | ● | ● | ● | | | | | | | | |
| Branco Off 44 | ● | ● | ● | | | | | | | | ● |

PLÁSTICOS



Cavaletti - Fábrica e Showroom
Rua Dr. Hiram Sampaio, 550
Erechim/RS Brasil 99.706-461
Fone/Fax: (54) 3520.4100
atendimento@cavaletti.com.br
www.cavaletti.com.br



Cavaletti

CADEIRAS PROFISSIONAIS



Cavaletti Go

Cavaletti Go

A linha Go nasceu para oferecer flexibilidade – estética e funcional – para ambientes contemporâneos. Assim, o conceito original se desdobra em múltiplas configurações para atender necessidades de cada utilização – seja uma sala de reuniões, um café, um espaço de espera ou mesmo um home office.

O resultado é um design puro, de linhas precisas e icônicas, que pode ser complementado com acessórios para níveis progressivos de conforto conforme o tempo de uso. Os complementos permitem modificar a estética do produto e adequá-lo à identidade de cada espaço.



product
design award

2013



CARACTERÍSTICAS

BRAÇOS VERSÁTEIS

Integrados ao design do produto, permitindo empilhamento.



PROTEÇÃO PARA EMPILHAMENTO

Contra-assento injetado para proteção durante o empilhamento.



ESTOFAMENTO INTELIGENTE

Permite adição de estofamento de forma independente no assento e no encosto, aumentando o nível de conforto de forma progressiva. Disponível em duas opções de espessura: 7mm ou 25mm.



ALTA CAPACIDADE DE EMPILHAMENTO

Empilhamento de até 15 cadeiras. Carrinho para transporte opcional.



CORES E ACABAMENTOS

PLÁSTICOS

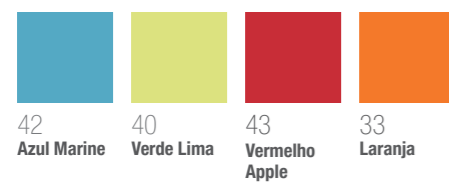
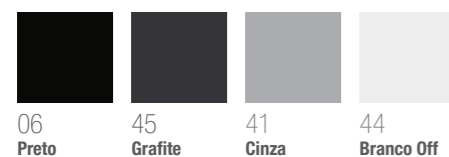

REVESTIMENTOS

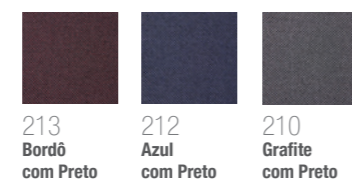

COSTURAS

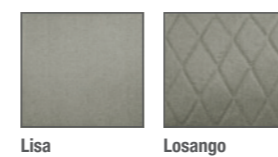

CONFIGURAÇÕES

GO BASIC

Braços Opcionais

GO SOFT

Braços Opcionais
Assento Estofado

GO COMPLETE

Braços Opcionais
Assento e Encosto Estofados

34003
Giratória



34006
Aproximação



34020
Banqueta Alta



MODELOS ESPECIAIS

Modelos Especiais disponíveis nas versões Basic, Soft e Complete.



34006 P
Aproximação
Pés Palito
Braços Opcionais



34006 P ROD
Aproximação
Pés Palito com Rodízios
Braços Opcionais



34006
Prancheta
Opções Fixa (U), Removível (UR)
e Escamoteável (UE)



34010
Longarina
Braços Opcionais
Disponível com 2, 3, 4 ou 5 lugares

DESENHOS TÉCNICOS

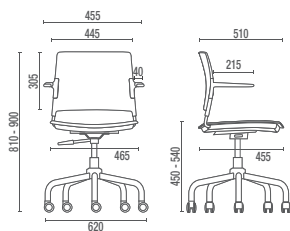

34003 **Giratória**

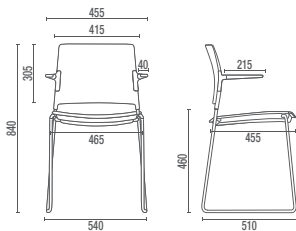

34006 **Aproximação**

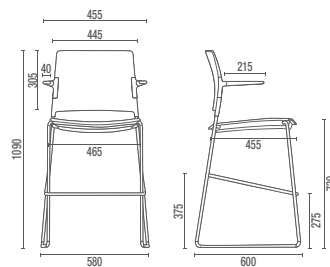

34020 **Banqueta Alta**

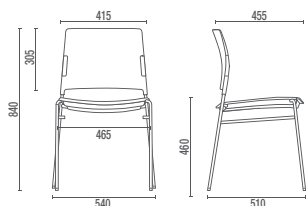

34006 P **Aproximação**

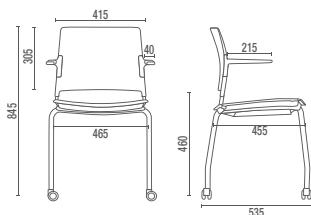

34006 P ROD **Aproximação Giratória**

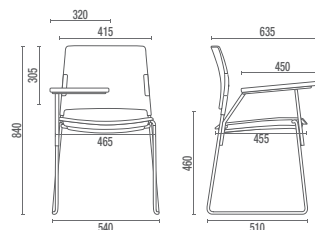

34006 U **Prancheta Escamoteável**

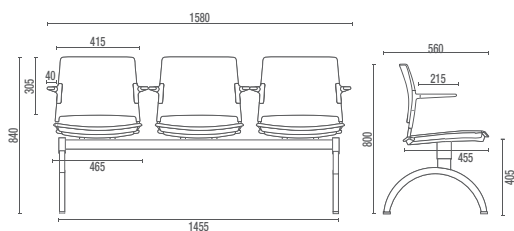

34010 **Longarina**

Larguras com Braço:

2L - 1055mm

3L - 1580mm

4L - 2100mm

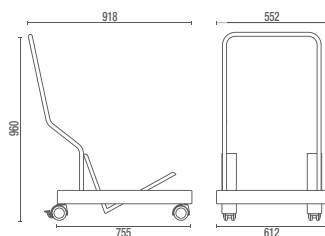

Carrinho

Empilhamento máximo: 15 unidades



Cavaletti - Fábrica e Showroom
Rua Dr. Hiram Sampaio, 550
Erechim/RS Brasil 99.700-000
Fone/Fax: (54) 3520.4100
atendimento@cavaletti.com.br
www.cavaletti.com.br



Cavaletti

CADEIRAS PROFISSIONAIS



Cavaletti Stay

Cavaletti Stay

A relação das pessoas com o tempo mudou...

A conectividade transformou a forma
como vivemos, trabalhamos, relaxamos.

Hoje, todo lugar pode ser um ambiente produtivo:
uma sala de espera, um café, uma biblioteca.

E esta mudança pede cadeiras adequadas
a este novo comportamento.

A linha Stay oferece o conforto ideal para todos
os momentos.



ATIVIDADE Stay
"een" conectividade
PROBLEMS
LEITURA
IDEIAS
Cavaletti
ES
TEMPO interação
Conforto
DIVERSÃO &
entes criativos



PRODUTIVIDADE Stay
 "in between" conectividade
NO PROBLEMS & LEITURA
 cadeiras praticidade
NOVAS IDEIAS Cavaletti
LIGHT Cavaletti
NEW CORES TEMPO interação
 ambiente criativos
COMFORTO & **DIVERSÃO**



CONFIGURAÇÕES



33106 P
 Aproximação Empilhável
 Estrutura Palito
 Braços Integrados
 Empilhamento máximo: 04 unidades



33107 A
 Aproximação
 Estrutura Arco
 Braços Integrados



33108
 Giratória
 Braços Integrados



33120
 Banqueta Alta
 Estrutura Palito
 Braços Integrados



33110
 Longarina
 Braços integrados

CORES



Cód. 02 Branco Cód. 41 Cinza Cód. 46 Marrom Café Cód. 06 Preto Cód. 42 Azul Marine Cód. 40 Verde Lima Cód. 38 Vermelho Cereja Cód. 33 Laranja

Estrutura com acabamento Cromado, pintura Preto Ultrafosco Microtexturizado ou Branco (modelo 33108).

DESENHOS TÉCNICOS

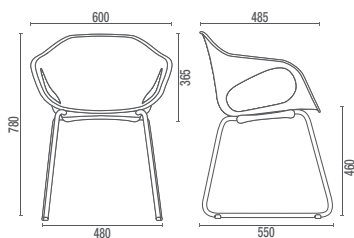

33107 A Aproximação

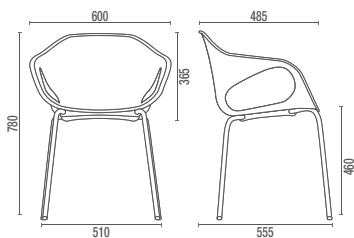

33106 P Aproximação Empilhável
Empilhamento máximo: 04 unidades

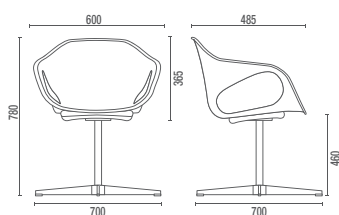
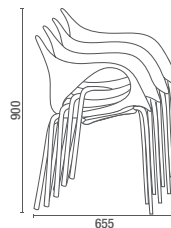

33108 Giratória

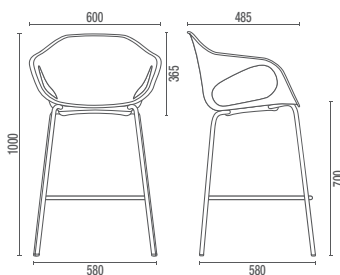

33120 Banqueta Alta

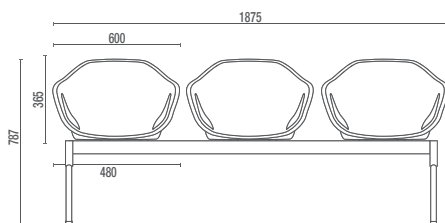

33110 Longarina

Larguras:
2L - 1200mm
4L - 2511mm
5L - 3140mm

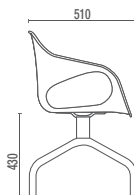

Cavaletti - Fábrica e Showroom
Rua Dr. Hiram Sampaio, 550
Erechim/RS Brasil 99.700-000
Fone/Fax: (54) 3520.4100
atendimento@cavaletti.com.br
www.cavaletti.com.br



Cavaletti®

CADEIRAS PROFISSIONAIS



Cavaletti Viva

Cavaletti Viva

Inspirada na natureza, a linha Viva traz tonalidades exclusivas para serem combinadas com diversas configurações, adaptando-se a qualquer ambiente. Além da variedade de cores, os produtos apresentam design Cavaletti, exclusivo e mais ergonômico.

Aproveite, imagine, crie. Viva!



Design
original
Cavaletti

VERSÕES



VIVA

Os modelos da linha Viva possuem o Pega-Mão, que facilita o seu manuseio e transporte. Disponível em quinze tonalidades diferentes.



VIVA SPM

A versão Viva SPM traz a cadeira Viva sem o Pega-Mão em quatro opções de cores: Azul, Vermelho, Branco e Preto. Disponível para todas as configurações.

CORES

VIVA



Eko



27
Verde Limão



28
Verde



30
Azul Marinho



34
Azul



32
Azul Noite



25
Lilás



23
Rosa



31
Vermelho



33
Laranja



16
Amarelo



Translúcido



02
Branco



12
Cinza



06
Preto

VIVA SPM



34
Azul



31
Vermelho



02
Branco



06
Preto

Disponível em cor personalizada para pedidos a partir de 500 unidades.

Criada a partir da combinação de termoplásticos, fibras naturais e alta tecnologia, o composto Eko utiliza fibra orgânica, oferecendo a aparência amadeirada com a durabilidade do plástico na opção de acabamento Eko.



CONFIGURAÇÕES



35008 P
Aproximação Empilhável
Estrutura Palito
Empilhamento máximo:
10 unidades



35028 P
Aproximação Empilhável
Estrutura Palito
Empilhamento máximo:
10 unidades



35007 P
Aproximação
Estrutura Palito



35007 SE
Aproximação
Estrutura Balanço
Assento Estofado
Disponível com Assento
Plástico sem Estofamento



35008 A
Aproximação Empilhável
Estrutura Arco
Empilhamento máximo:
05 unidades



35004
Giratória
Braço Z
Base Viva
Mecanismo Flange



35004 SL
Giratória
Braço SL
Base de Aço com Capa
Mecanismo Flange



35008 PU
Universitária
Estrutura Palito com Grade
Prancheta Removível



35007 Z
Aproximação
Braços Integrados



35007 Z ROD
Aproximação com Rodízios
Braços Integrados



35010
Longarina



Mecanismo de União
Modelos 35007 Z



Estofamento
Opção de assento e/ou encosto
estofados. Disponível para todos
os modelos.



35008 PUE
Universitária
Opção de Prancheta
Escamoteável

DESENHOS TÉCNICOS

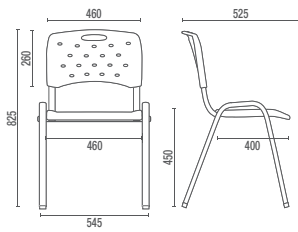

35008 P Aproximação Empilhável

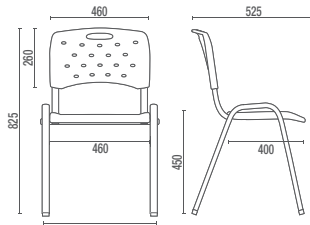

35028 P Aproximação Empilhável

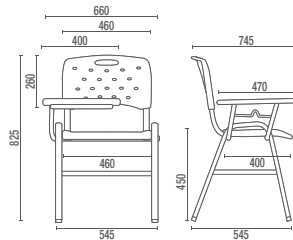

35008 PU Universitária

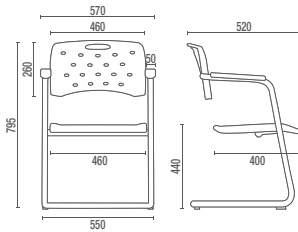

35007 S Aproximação

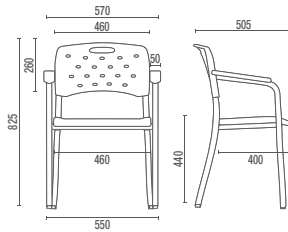

35007 P Aproximação

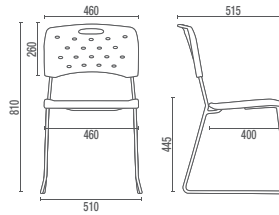

35008 A Aproximação Empilhável

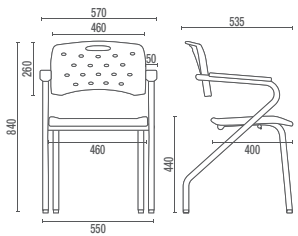

35007 Z / Aproximação

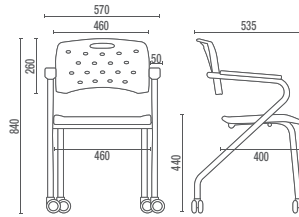

35007 Z ROD Aproximação com Rodízios

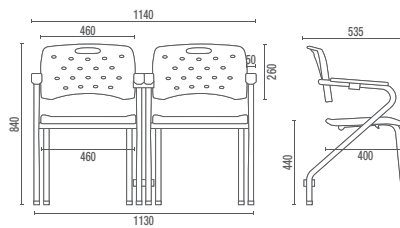

35007 Z Aproximação com Mecanismo de União

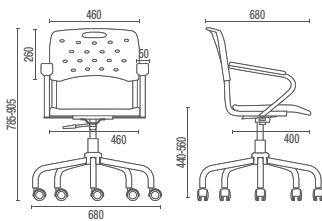

35004 Giratória Base Viva

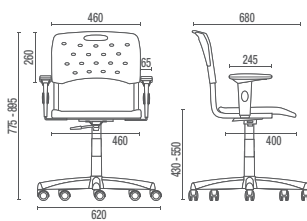

35004 Giratória Base em Aço com Capa

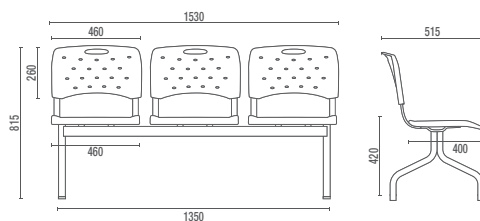

35010 Longarina

Larguras sem Braço:

2L - 1026mm

3L - 1530mm

4L - 2052mm

5L - 2578mm



Cavaletti - Fábrica e Showroom
Rua Dr. Hiram Sampaio, 550
Erechim/RS Brasil 99.700-000
Fone/Fax: (54) 3520.4100
atendimento@cavaletti.com.br
www.cavaletti.com.br



®

Cavaletti

CADEIRAS PROFISSIONAIS



Cavaletti Fun

Cavaletti Fun

A linha Fun é direcionada a ambientes informais, nos quais um mobiliário leve e de linhas básicas ajuda a compor espaços agradáveis para o convívio e descontração. São modelos variados, todos disponíveis em cores que combinam com uma atmosfera alegre e relaxante.



14020
Banqueta
Assento Estofado



14020
Banqueta
Assento em Madeira com Verniz



14015
Banqueta Alta com Encosto



14015
Banqueta Alta



14015
Banqueta Baixa



746
Revisteiro



14016
Banqueta com Encosto



14016
Banqueta



14019
Banqueta



747
Revisteiro



36016
Banco Giratório
Base em Alumínio



Puff

DESENHOS TÉCNICOS

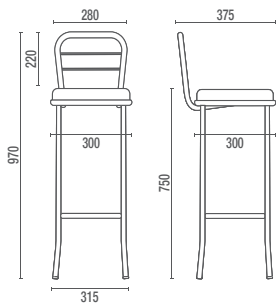

14015 Banqueta Alta com Encosto

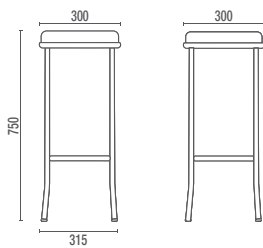

14015 Banqueta Alta

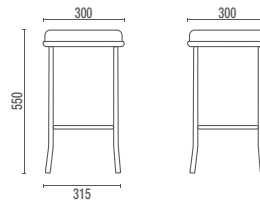

14015 Banqueta Baixa

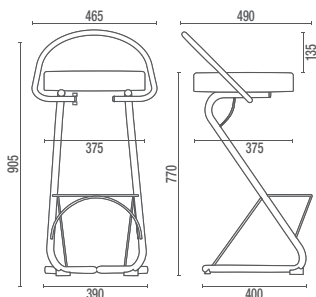

14016 Banqueta com Encosto

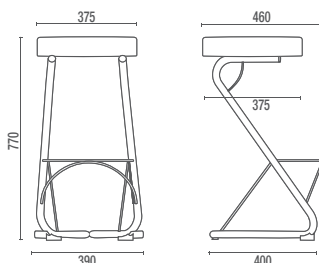

14016 Banqueta

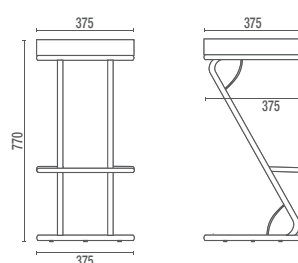

14019 Banqueta

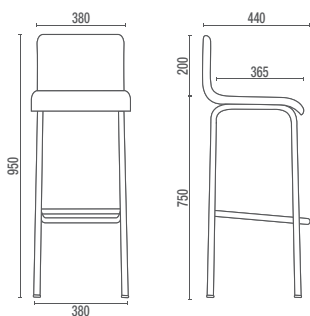

14020 Banqueta

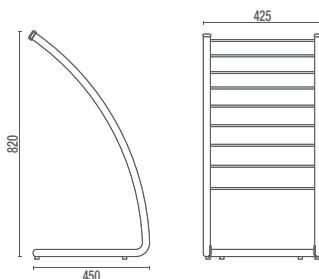

746 Revisteiro

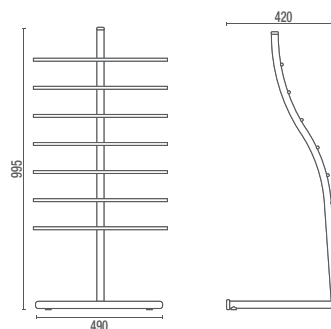

747 Revisteiro

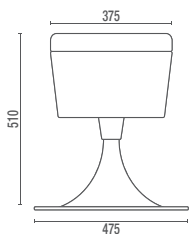

36016 Banco Giratório

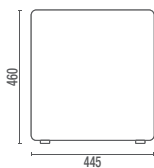

Puff

Cavaletti®

CADEIRAS PROFISSIONAIS



Cavaletti Spot

Cavaletti Spot

Direcionada a áreas de espera, lounges e espaços coletivos, os modelos da linha Spot destacam-se pela singularidade do desenho, podendo ser utilizados tanto em ambientes comerciais quanto residenciais.



36060
Poltrona Espera
Giratória
Base Alumínio 4 Hastes
Concha em Madeira
com Estofamento



REVESTIMENTOS
Diversas opções de revestimento:
Poliéster, Vinil, Space ou Couro
Ecológico.



BASES E ESTRUTURAS
Opções de base Fixa e Giratória conforme o modelo.
Acabamento Cromado (bases em Aço), Polido (bases
em Alumínio) ou Pintura Epoxi Prata ou Preto Ultrafosco
Microtexturizado (bases em Aço).

CONFIGURAÇÕES



36010
Poltrona Espera
Giratória
Base Alumínio Disco



36010
Poltrona Espera
Fixa ou Giratória
Base 4 Pés



36040
Poltrona Espera
Estrutura Arco



36050
Poltrona Espera
Fixa ou Giratória



36060
Poltrona Espera
Giratória
Base Alumínio 4 Hastes
Concha Estofada

DESENHOS TÉCNICOS

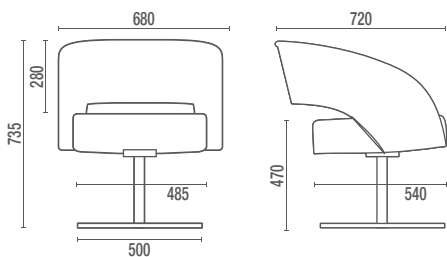

36010 Poltrona Espera Base Disco

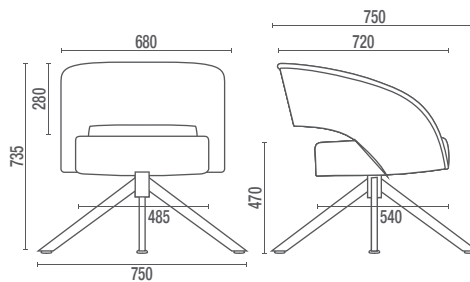

36010 Poltrona Espera Base 4 Pés

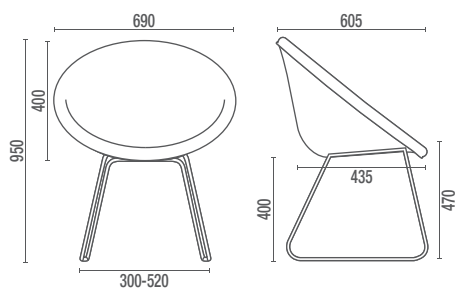

36040 Poltrona Espera

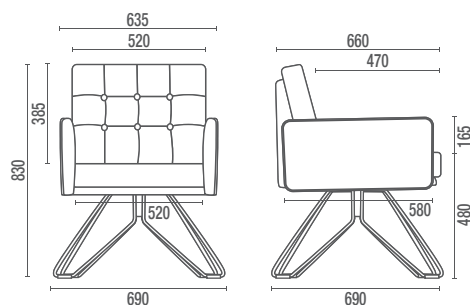

36050 Poltrona Espera

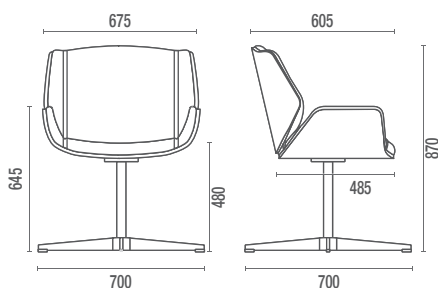

36060 Poltrona Espera



Cavaletti - Fábrica e Showroom
 Rua Dr. Hiram Sampaio, 550
 Erechim/RS Brasil 99.700-000
 Fone/Fax: (54) 3520.4100
 atendimento@cavaletti.com.br
 www.cavaletti.com.br



Cavaletti

CADEIRAS PROFISSIONAIS



Cavaletti Box

Cavaletti Box

Criada para ambientes de recepção e espera, a linha Box proporciona conforto na medida ideal. Os estofados são facilmente combináveis e suas dimensões compactas otimizam o aproveitamento do espaço.



36020
Poltrona Espera
Fixa ou Giratória
Base 4 Pés

CONFIGURAÇÕES



36105
Sofá Espera
1 Lugar



36105
Sofá Espera
2 Lugares



12004
Sofá Espera
1 Lugar



12004
Sofá Espera
2 Lugares



12004
Sofá Espera
3 Lugares



12105
Sofá Espera
1 Lugar



12105
Sofá Espera
2 Lugares



12105
Sofá Espera
3 Lugares

DESENHOS TÉCNICOS

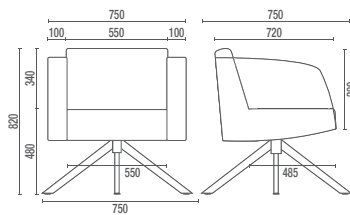

36020 Poltrona Espera

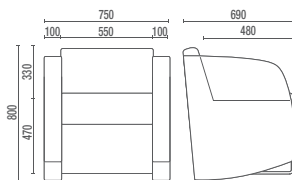

36105 Sofá Espera

Larguras:
1L - 750mm
2L - 1280mm

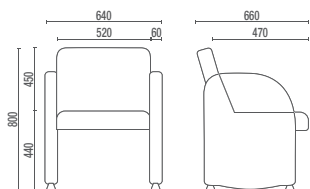

12004 Sofá Espera

Larguras:
1L - 520mm
2L - 1170mm
3L - 1700mm

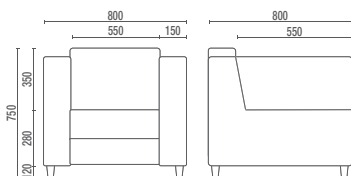

12005 Sofá Espera

Larguras:
1L - 800mm
2L - 1300mm
3L - 1800mm



Cavaletti - Fábrica e Showroom
Rua Dr. Hiram Sampaio, 550
Erechim/RS Brasil 99.700-000
Fone/Fax: (54) 3520.4100
atendimento@cavaletti.com.br
www.cavaletti.com.br



Cavaletti

CADEIRAS PROFISSIONAIS

Cavaletti Spin

Cavaletti Spin

O sistema de sofás Spin proporciona configurações flexíveis para os mais diferentes arranjos de espaços colaborativos. São módulos lineares, curvos, pufes e acessórios que tornam os ambientes coletivos mais produtivos e versáteis.



Layout Lounge



Layout Espera



Layout Reunião



Layout Hub



CARACTERÍSTICAS



Layout Fórum

OBS: Lousa, aparadores, floreiras e vasos apenas ilustrativos.

CONFIGURAÇÕES

- 

36.813
Módulo Reto 1300mm
Conexão USB Opcional
- 

36.865
Módulo Reto 650mm
Conexão USB Opcional
- 

36.805
Módulo Mesa
Tampo de Madeira
Conexão USB Opcional
- 

36.845 IN
Módulo Curvo Encosto Interno 45°
- 

36.890 IN
Módulo Curvo Encosto Interno 90°
Conexão USB Opcional
- 

36.818
Módulo Ponta Encosto Interno 180°
Conexão USB Opcional
- 

36.845 EX
Módulo Curvo Encosto Externo 45°
- 

36.890 EX
Módulo Curvo Encosto Externo 90°
Conexão USB Opcional
- 

PUFF REDONDO
Pufe Redondo Pequeno
- 

36.814
Banqueta Spin
- 

36.801
Aparador Spin
- 

11.801
Mesa Talk
- 

36.805 REDONDA
Mesa Redonda 1200mm
- 

36.805 QUADRADA
Mesa Quadrada 750 x 750mm
- 

11.801 4L
Mesa Retangular
Conexão USB/Elétrica Opcional

DESENHOS TÉCNICOS

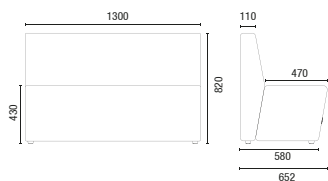

36.813 **Módulo Reto 1300mm**

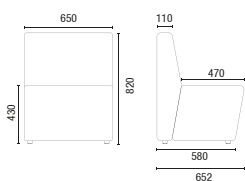

36.865 **Módulo Reto 650mm**

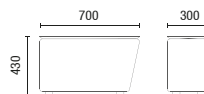

36.805 **Módulo Mesa**

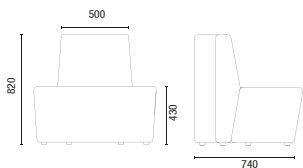

36.845 IN **Módulo Curvo Encosto Interno 45°**

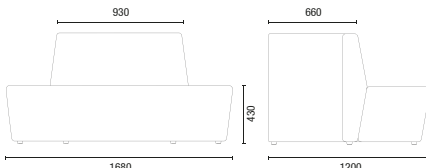

36.890 IN **Módulo Curvo Encosto Interno 90°**

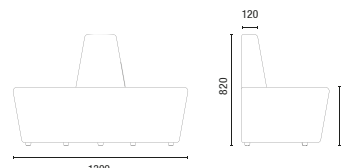

36.818 **Módulo Ponta Encosto Interno 180°**

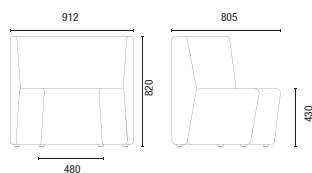

36.845 EX **Módulo Curvo Encosto Externo 45°**

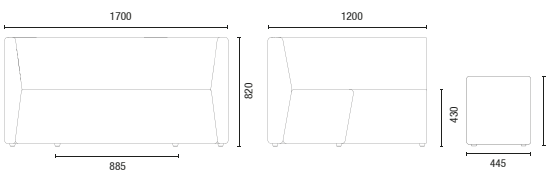

36.890 EX **Módulo Curvo Encosto Externo 90°**

PUFF REDONDO **Pufe Redondo Pequeno**

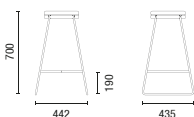

36.814 **Banqueta Spin**

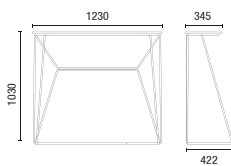

36.801 **Aparador Spin**

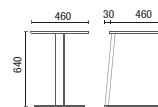

11.801 **Mesa Talk**

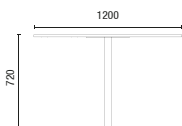

36.805 REDONDA **Mesa Redonda 1200mm**

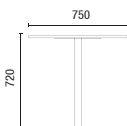

36.805 QUADRADA **Mesa Quadrada 750 x 750mm**

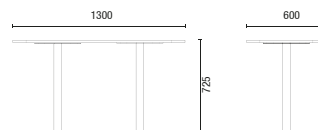

11.801 4L **Mesa Retangular**

OBS: Medidas extremas obtidas sem o uso de gabarito de carga.



Cavaletti - Fábrica e Showroom
Rua Dr. Hiram Sampaio, 550
Erechim/RS Brasil 99.706-461
Fone/Fax: (54) 3520.4100
atendimento@cavaletti.com.br
www.cavaletti.com.br



Cavaletti

CADEIRAS PROFISSIONAIS

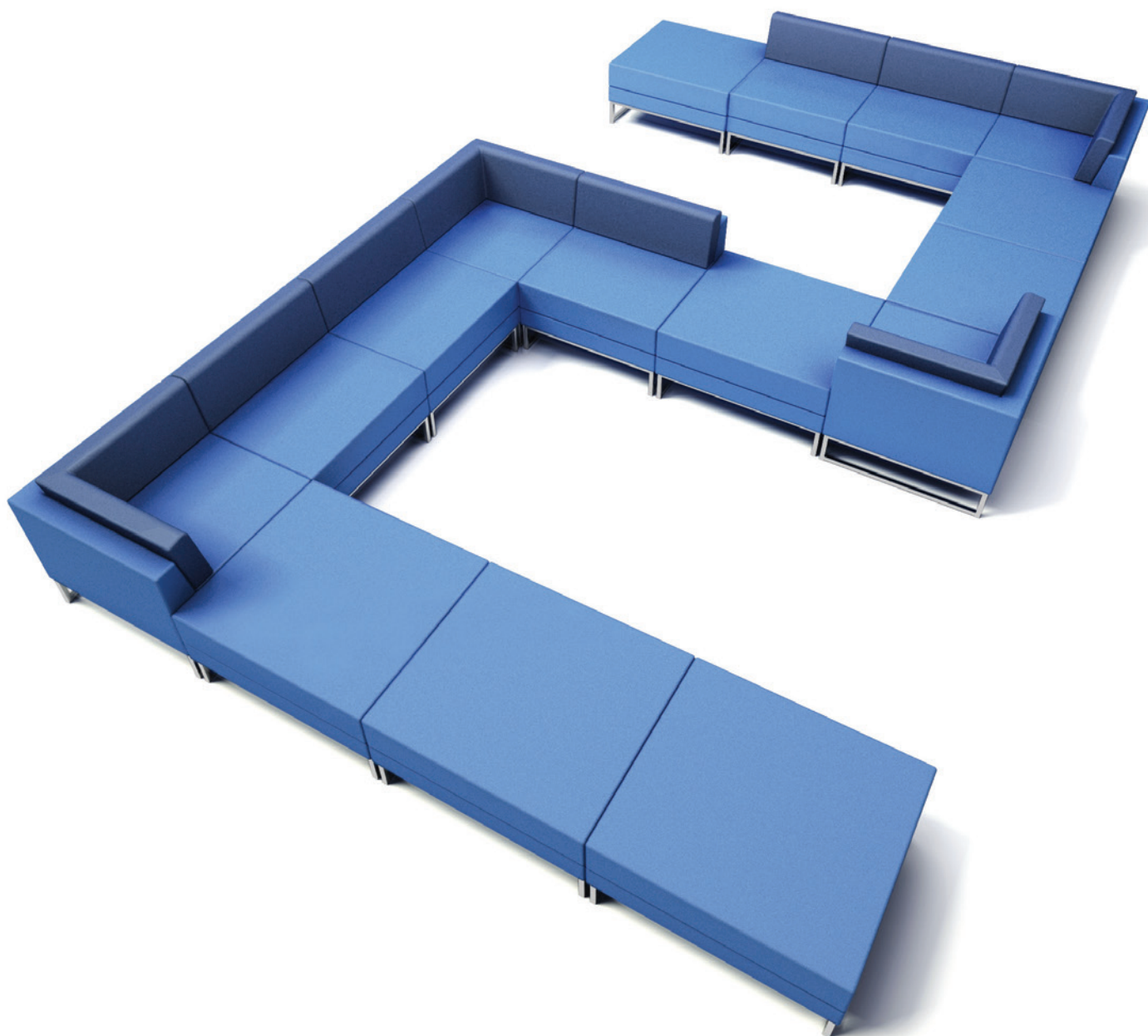

Cavaletti Connect

Cavaletti Connect

A linha de estofados Connect apresenta um design universal, com construção simples e prática, trazendo conforto de modo inteligente para espaços de lounge e estar em geral. Seus módulos permitem diferentes arranjos de montagem, oferecendo dinamismo e beleza aos ambientes.



CONFIGURAÇÕES



36205
Poltrona
Braço Duplo e Encosto



36205
Sofá Canto
Braço e Encosto



36205
Sofá Central
Encosto



36205
Banco

DESENHOS TÉCNICOS

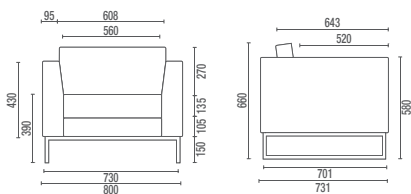

36205 Poltrona

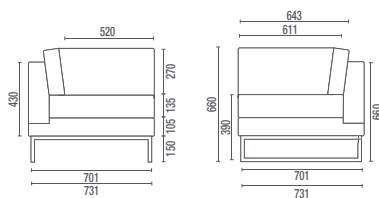

36205 Sofá Canto

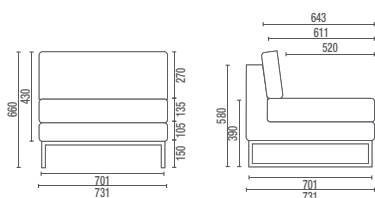

36205 Sofá Central

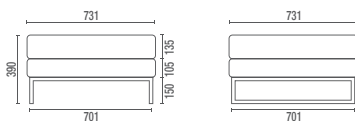

36205 Banco



Cavaletti - Fábrica e Showroom
Rua Dr. Hiram Sampaio, 550
Erechim/RS Brasil 99.700-000
Fone/Fax: (54) 3520.4100
atendimento@cavaletti.com.br
www.cavaletti.com.br



Cavaletti[®]

CADEIRAS PROFISSIONAIS



Cavaletti Talk

Cavaletti Talk

Colaboração é a tendência contemporânea no mundo do trabalho. A linha Cavaletti Talk foi projetada para aumentar a produtividade, estimulando reuniões e conversas rápidas e informais. Além das versões básicas sem encosto ou com encosto baixo, conheça a opção high-back (encosto alto), que cria um ponto de reunião dentro do escritório ou lounge, otimizando a instalação, gerando economia de espaço (diagrama ao lado) e facilitando mudanças futuras de layout.

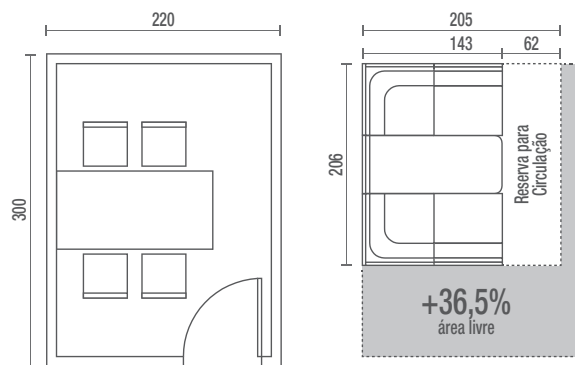

Sala de Reunião Tradicional
6,60 m²

Ponto de Reunião Talk
3m² + 1,25m² (área de circulação)

CONFIGURAÇÕES



36505 Poltrona
Braço Duplo e Encosto



36505 Sofá Canto
Braço e encosto



36505 Sofá Central
Encosto



36505 Banco



36.555 HB Duplo



36.575 HB Face-to-Face
Mesa Interna
Box Eletrificado (Opcional)



36.565 HB Reunião
Mesa Interna
Box Eletrificado (Opcional)



11.801 Mesa Talk

DESENHOS TÉCNICOS

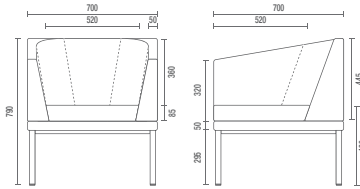

36.505 Poltrona

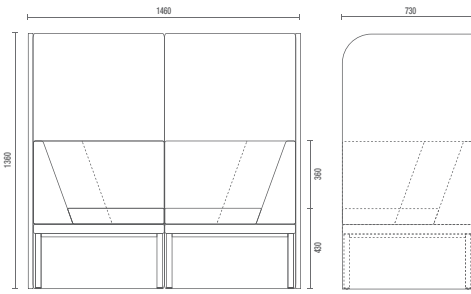

36.555 HB Duplo

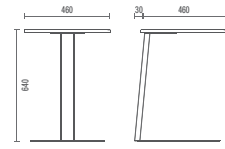

11.801 Mesa Talk

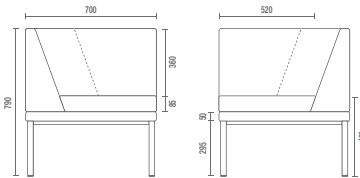

36.505 Sofá Canto

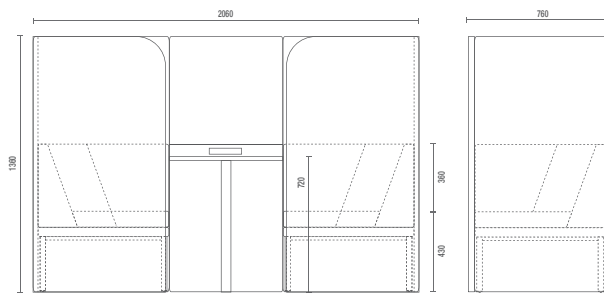

36.575 HB Face-to-Face

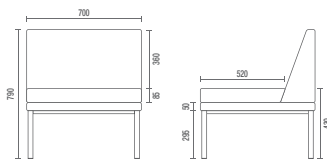

36505 Sofá Central

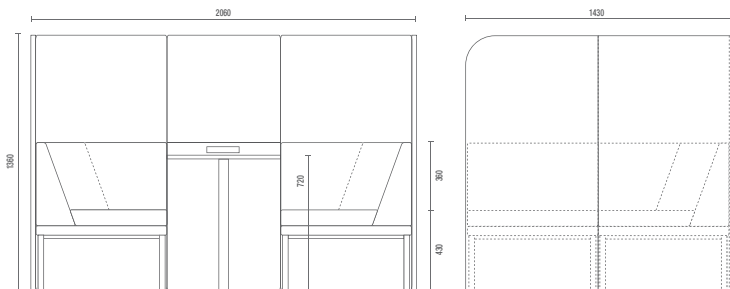

36.565 HB Reunião

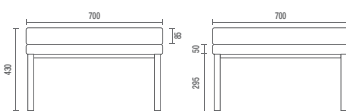

36505 Banco



Cavaletti - Fábrica e Showroom
 Rua Dr. Hiram Sampaio, 550
 Erechim/RS Brasil 99.706-530
 Fone/Fax: (54) 3520.4100
 atendimento@cavaletti.com.br
 www.cavaletti.com.br





Cavaletti[®]

CADEIRAS PROFISSIONAIS

Cavaletti Coletiva



Cavaletti Coletiva

Projetada para atender uma grande variedade de arquiteturas e tipos de evento, a linha Coletiva se destaca pela construção sólida que objetiva maior durabilidade. Com opções de acabamentos e acessórios, os produtos da Coletiva garantem ótimos níveis de usabilidade ao longo de toda sua vida útil.

CONFIGURAÇÕES



Duas alturas de encosto disponíveis:
Diretor e Presidente.



Opção de carenagem de proteção
do encosto.



Assento retrátil com opção
de carenagem.



12020
Auditório
Braços Duplos



Braços Duplos ou Intercalados
com Apoio de Braço em PU.



Lateral revestida em tecido
ou com acabamento em Madeira
com duas opções de cores.



Opção de Prancheta Escamoteável.



1001
Empilhável
Empilhamento máximo: 10 unidades



1002
Empilhável
Empilhamento máximo: 10 unidades



Prancheta Removível
Opcional para 1001 e 1002



1003
Empilhável
Empilhamento máximo: 05 unidades



35013
Empilhável
Braços Integrados
Empilhamento máximo: 05 unidades



1100
Carrinho para Transporte
Disponível para os modelos
1001, 1002, 1003 e 35013.



12006
Auditório
Braços Intercalados ou Duplos



12006 U
Prancheta Escamoteável
Opcional para 12006



12011
Auditório
Braços Intercalados ou Duplos



12011 U
Prancheta Escamoteável
Opcional para 12011

DESENHOS TÉCNICOS

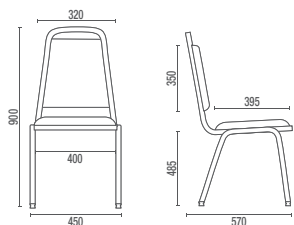

1001 Empilhável

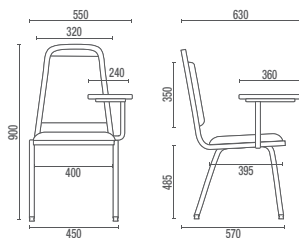

1001 U Empilhável com Prancheta

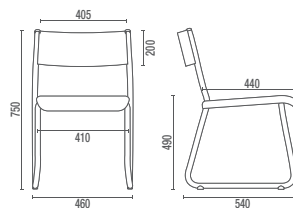

1003 Empilhável

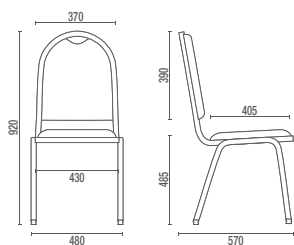

1002 Empilhável

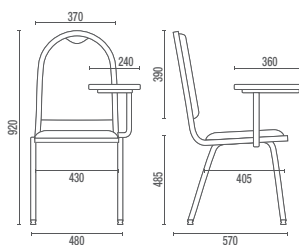

1002 U Empilhável com Prancheta

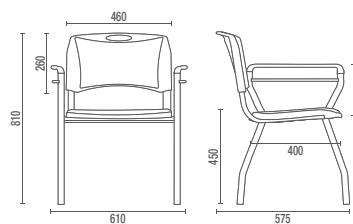

35013 Empilhável

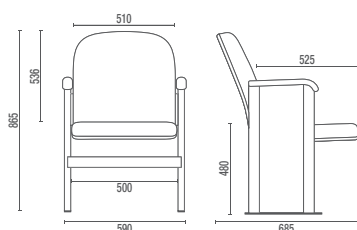

12006 Auditório

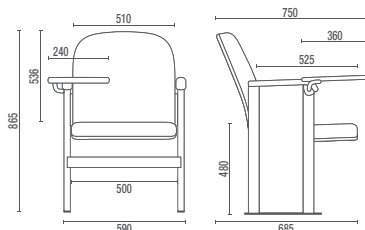

12006 UE Auditório com Prancheta

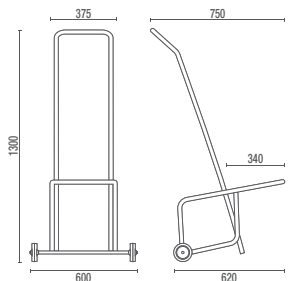

1100 Carrinho para Transporte

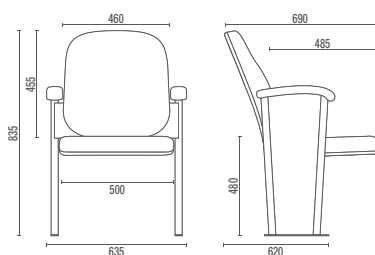

12011 Auditório

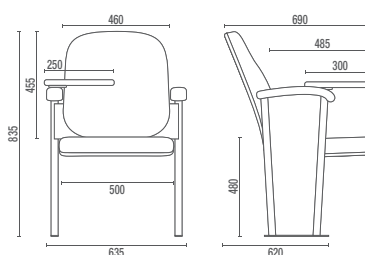

12011 UE Auditório com Prancheta

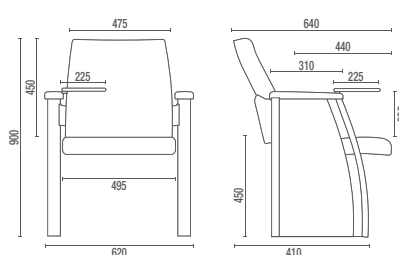

12020 UE Auditório com Prancheta



Cavaletti - Fábrica e Showroom
Rua Dr. Hiram Sampaio, 550
Erechim/RS Brasil 99.700-000
Fone/Fax: (54) 3520.4100
atendimento@cavaletti.com.br
www.cavaletti.com.br

